

YAMADA

www.yamada-europe.com



PRODUCT GUIDE

**High-Performance Air-Powered Double Diaphragm Pumps
Manufactured in Japan**

About Yamada...

Yamada Europe B.V.
Aquamarijnstraat 50
7554 NS Hengelo
The Netherlands
Phone +31 (0)74-242 2032
Fax +31 (0)74-242 1055
E-mail: sales@yamada-europe.com
Web: www.yamada-europe.com



The Yamada Corporation has been a leading producer of industrial equipment since 1905, and of fluid handling products for over 60 years. As a leader in pneumatic pumping technology, Yamada is known in many industries worldwide for its innovative products, superior quality and unmatched reliability. Yamada has an impressive history of delivering new products and solving customer problems which confirm Yamada's position as the industry leader.

Yamada's reputation for manufacturing top quality products, allied with continuing efforts in research and development have created a strong foundation for market leadership. As an ISO 9001 certified corporation, stringent quality procedures are followed throughout the manufacturing process, including liquid testing of every pump prior to shipping.

The Yamada Corporation has its primary headquarters in Tokyo, Japan, with manufacturing based in Sagami-hara City. Assembly facilities are located in Chicago, Illinois, USA and Hengelo, The Netherlands.

Yamada Europe B.V., a wholly owned subsidiary of Yamada Corporation, was established in 1985 to provide sales and service and support for Europe, the Middle East and Africa, through a highly trained network of distributors.

Our professional staff provides:

- Customer service
- Product training
- Research & development
- Parts and service for all Yamada pumps
- Application engineering
- Industry knowledge

With over 150 distributors worldwide, Yamada is in position to service the global market needs. Contact Yamada Europe for the closest distributor location.

We build our pumps with quality and innovation. This is the cornerstone of the Yamada design and manufacturing process.

For additional information, product literature, and drawings please visit www.yamada-europe.com or contact our sales team at +31 (0)74-242 2032.



CONTENTS

Inside a Yamada Pump	2
Air Valve Technology	3
Non-Metallic Components ...	4
Ten Features of a	
Yamada Diaphragm Pump ...	4
NDP-05 Series Pumps	5
DP-10/15 Series Pumps	6
NDP-10/15 Series Pumps	8
NDP-20 Series Pumps	10
NDP-25 Series Pumps	12
NDP-40 Series Pumps	14
NDP-50 Series Pumps	16
NDP-80 Series Pumps	18
High Pressure 2:1 Pumps ...	20
Manifold Options	20
XDP Series Pumps	21
Powder Series Pumps	21
Drum Series Pumps	22
NDP-32 Serie Pump	22
FDA Compliant Pumps	23
DM(X) Series Pumps	23
Solids Handling Pump	24
Liquid Level Controller	25
Dry-Run Detection	25
Pulsation Dampeners	26
Pump Diaphragms	27
Optional Coatings	27
Additional Options	28
Installation Diagram	29
Understanding	
Performance Curves	29

Engineered to Perform

Fully bolted leak free mating surfaces

All Yamada pumps incorporate registered fit bolted construction, which simplifies reassembly after maintenance. No leak-prone clamp bands are utilized.

One air valve fits all

The NDP-40, 50 & 80 series pumps utilize one common air valve assembly, reducing parts inventory and assembly confusion. The NDP-20 & 25 have a common air valve as well. One air valve concept is used in all Yamada NDP series pumps!

Outside accessible

Inspection or maintenance of every Yamada air valve can be performed without removing the pump from service.

Pilot valve

Unique design is an individual modular pilot valve that actuates the air valve. It is maintenance-free, with no cumbersome snap rings or lubricated dynamic o-rings to replace or repair.

Diaphragm dynamics

Extensive research has led to the development of an optimal stroke length that maximizes diaphragm life and performance while minimizing downtime and maintenance costs.

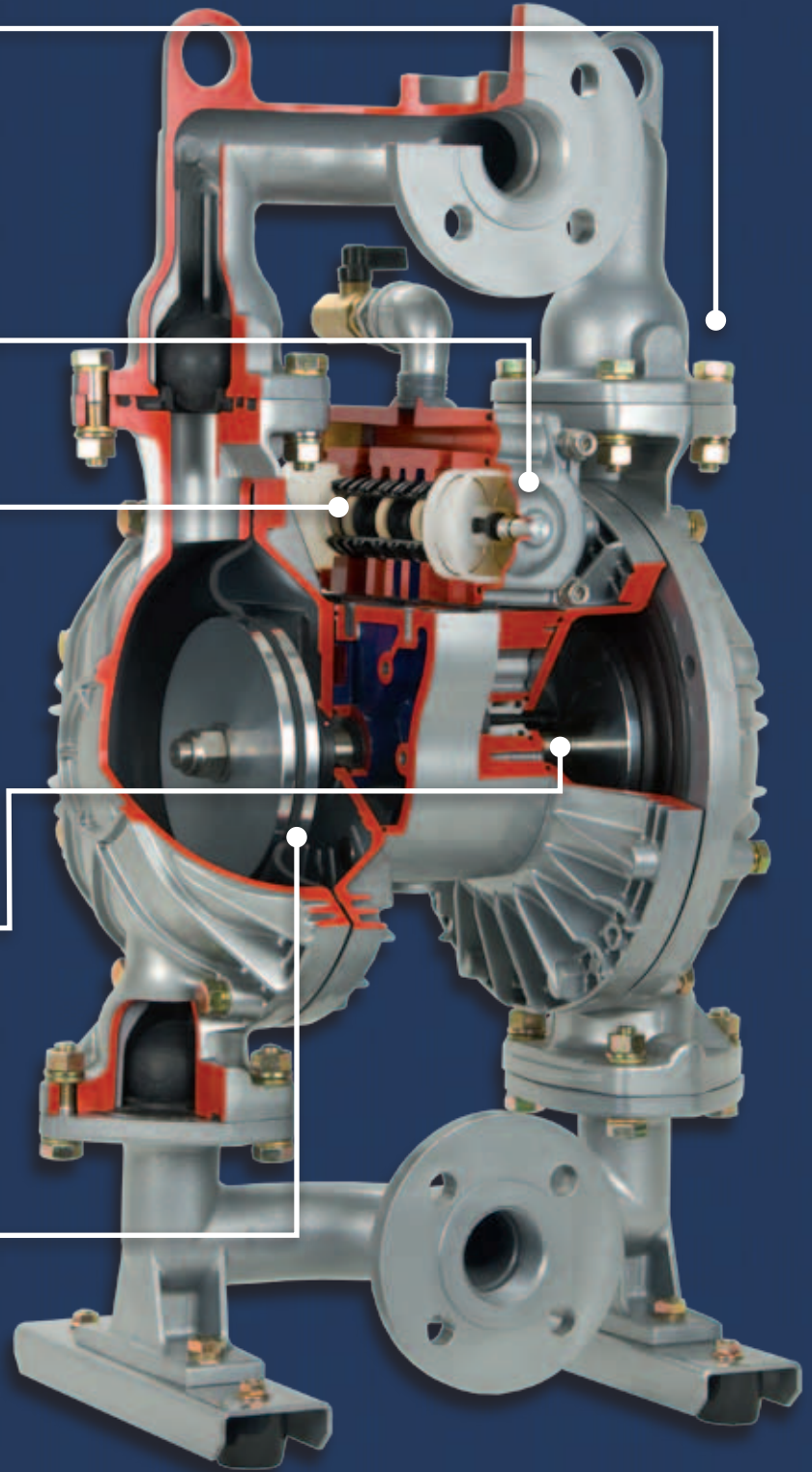

Built to Last

Air valve technology



Air valve technology is the heart of the air-powered double diaphragm pump and determines reliability. Yamada holds three patents on its field proven valve and enjoys a superior reputation throughout the industry.

Unified Air Valve Concept

To simplify, Yamada offers two common size air valve assemblies within five sizes of pumps (3/4" & 1" pumps and 1-1/2" 2" & 3" pumps) further reducing reassembly confusion and parts inventory. We try to unify to reduce multiple air valve designs and revisions. Whether your pumps are functioning continuously or intermittently; at high or low pressure; using dirty or clean air; Yamada offers **one field proven design**.

Truly Non-Lubricated Air Valve

The patented air valve on all NDP series pumps never requires lubrication or pre-packing. The advanced design eliminates the need for external lubrication which can lead to pumpage contamination and maintenance headaches. **Yamada is proud to be the originator of non-lubricated air valve technology for air-powered double diaphragm pumps.**

Component Replaceable

All Yamada air valves can be restored with individual components, without requiring complete valve and housing replacement.

Non-Stalling

A patented non-centering, spring-assisted shifter is incorporated into every NDP Series pump, ensuring a positive shift every time.

Common-size air valve assemblies reduce parts confusion.



Air Valve fits NDP-20 (3/4") & NDP-25 Series (1")



Air Valve fits NDP-40 (1-1/2"), NDP-50 (2"), & NDP-80 (3") Series Pumps

The 304 stainless steel C-springs provide exceptional durability and longevity and are tested to last over **300 million cycles!** The spring assist also aides in long dead head applications for reliable startup.



For additional information on Yamada products and services, visit www.yamada-europe.com

Non-Metallic Components

Non-Metallic Components

Yamada Engineers utilize state-of-the-art solid modeling and finite element analysis techniques, including rib and shell methods of injection molding to design non-metallic parts structure. This "patented" technique greatly increases the component strength and reduces material usage.

NDP-40, 50, & 80 Series Non-Metallic Pump Base

The tubular 304 Stainless Steel base was designed to simplify rebuilding procedures and to absorb weight distribution. Maintenance operations are streamlined by mounting the base directly to the air motor so that the pump can sit upright on a workbench for most of the service. The radially bent tubular steel base is rated to 85,000 PSI giving it exceptional strength vs. welded angle designs.

**NDP-40
Polypropylene**

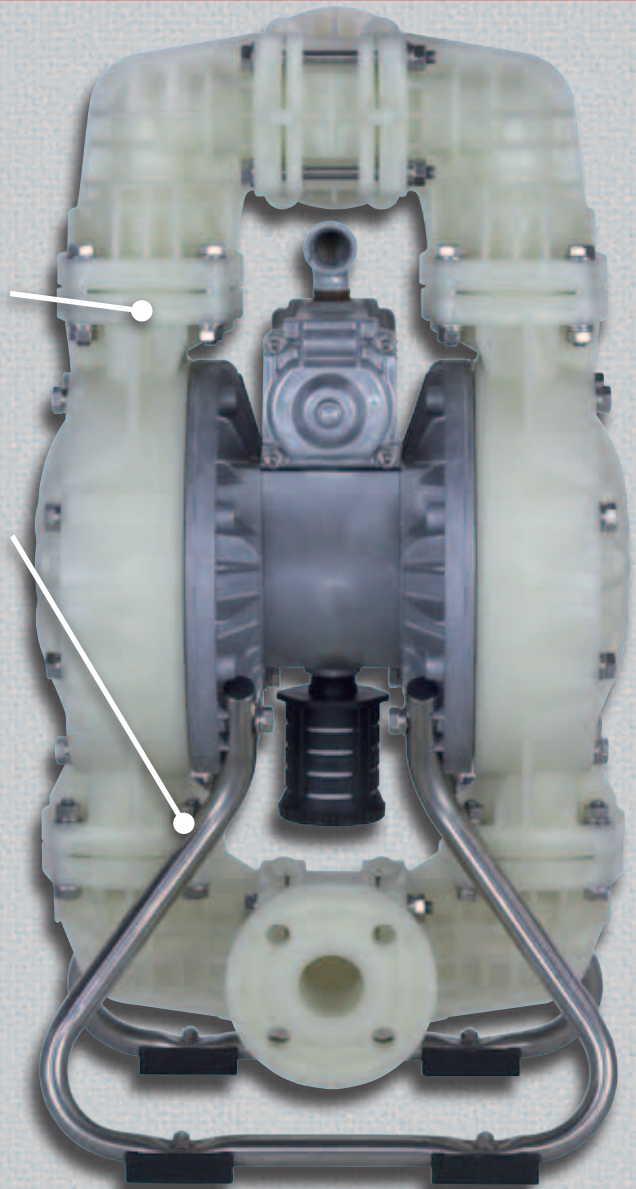

Ten Features of a Yamada Diaphragm Pump

1. **Handles a wide variety of fluids with high solids content:** No close fitting or rotating parts so liquid with high solids content and/or size can be easily pumped.
2. **Self Priming:** The Yamada pump design (incorporating internal check valves) allows for high suction lift even at dry start-up and with heavier fluids.
3. **Ability to run dry:** No close fittings or sliding parts are at risk—the pump can run dry without damage.
4. **Variable flow rate and discharge pressure:** Yamada pumps will run at any setting within their operating range simply by adjusting the air inlet pressure and system conditions. One pump can fit a broad spectrum of applications.
5. **Portable/Simple Installation:** Yamada pumps transport easily to the application site. Simply connect your air supply line and liquid lines; the pump is ready to perform. There are no complex controls to install and operate.
6. **Dead Head:** Because the discharge pressure can never exceed air inlet pressure, the discharge line can be closed with no damage or wear. The pump will simply slow down and stop.
7. **Shear Sensitive:** The gentle nature and minimal parts contact with the liquid makes Yamada pumps an excellent choice for shear sensitive fluids.
8. **Explosion Proof:** Yamada pumps are operated by compressed air, therefore, they are intrinsically safe.
9. **Submersible:** If external components are compatible—Yamada pumps can be submerged in the liquid by simply running the exhaust line above the liquid level.
10. **Pumping efficiency remains constant:** There are no rotors, gears, or pistons, which wear over time and lead to the gradual decline in performance/flow rate.

For additional information on Yamada products & services, visit www.yamada-europe.com.

NDP-05 Series

11,7 l/m (3.1 GPM) Maximum Capacity
1/4" (5 mm) Port Size

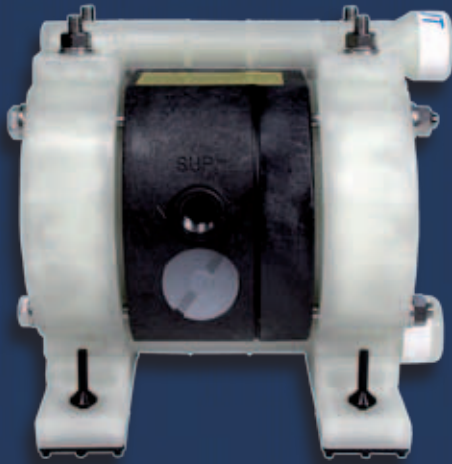

↑ NDP-05 Polypropylene

Dimensions: 156 mm W x 152 mm H
Net Wt.: 1,36 kg (3.0 lbs.)
Shipping Wt.: 1,81 kg (4.0 lbs.)

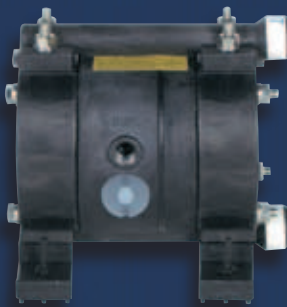

NDP-05 Kynar®

Dimensions: 156 mm W x 152 mm H
Net Wt.: 1,67 kg (3.7 lbs.)
Shipping Wt.: 2,1 kg (4.7 lbs.)

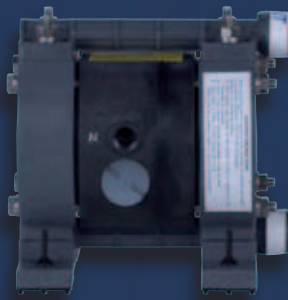

NDP-05 Groundable Acetal

Dimensions: 156 mm W x 152 mm H
Net Wt.: 1,67 kg (3.7 lbs.)
Shipping Wt.: 2,1 kg (4.7 lbs.)



NDP-05 Aluminum

Dimensions: 155 mm W x 149 mm H
Net Wt.: 1,5 kg (3.3 lbs.)
Shipping Wt.: 1,9 kg (4.3 lbs.)

Specifications

Port Dimensions

Intake & discharge	1/4" 5 mm Female Rc
Air inlet (incl. ball valve):	1/4" 5 mm Female Rc
Air exhaust (internal silencer):	3/8" 10 mm Female Rc

Maximum Liquid Temperature

Fitted with Teflon® (PTFE) diaphragm

Pump Material	Temperature
Polypropylene (PPG)	82°C (180°F)
Kynar® (PVDF)	100°C (212°F)
Groundable Acetal	82°C (180°F)
Aluminum (ADC-12)	100°C (212°F)
Stainless Steel (316)	100°C (212°F)

Air Supply Pressure (All Models)

1,4 – 7 Bar (0,14 – 0,7 MPa) (20 – 100 PSI)

Discharge Volume Per Cycle

29 cc (0.0078 US gallons)

Maximum Cycles Per Minute: 400

Maximum Dry Suction Lift: 1,5 m (5 feet)

Air Motor

Standard: Ryton® air motor

Model Number Nomenclature

Polypropylene (PPG)	NDP-05FPT
Kynar® (PVDF)	NDP-05FVT
Groundable Acetal	NDP-05FDT
Aluminum (ADC-12)	NDP-05FAT
Stainless Steel (316)	NDP-05FST

Performance Curve

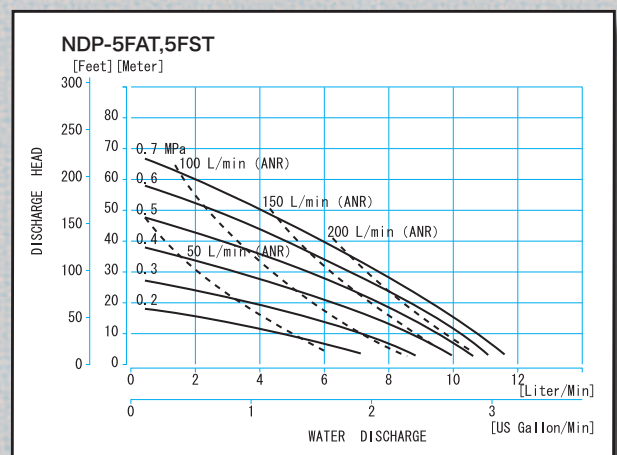

DP-10 Series / DP-15 Series

22 l/m (6 GPM) Maximum Capacity
3/8" (10 mm) Port Size

28 l/m (7.4 GPM) Maximum Capacity
1/2" (15 mm) Port Size

DP-10 Polypropylene
Dimensions:
196 mm W x 196 mm H
Net Wt.: 3,1 kg (6.8 lbs.)
Shipping Wt.: 4,0 kg (8.8 lbs.)

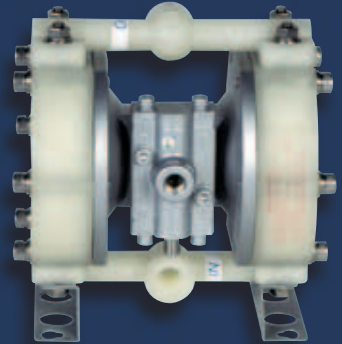

DP-10 Aluminum
Dimensions:
186 mm W x 241 mm H
Net Wt.: 3,6 kg (7.9 lbs.)
Shipping Wt.: 4, 5 kg (9.9 lbs.)

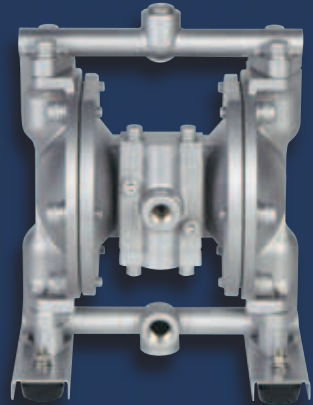

DP-10 Stainless Steel
Dimensions:
186 mm W x 241 mm H
Net Wt.: 5,3 kg (11.7 lbs.)
Shipping Wt.: 6,2 kg (13.7 lbs.)



DP-15 Groundable Acetal
Dimensions:
246 mm W x 297 mm H
Net Wt.: 4,0 kg (9 lbs.)
Shipping Wt.: 5,4 kg (12 lbs.)

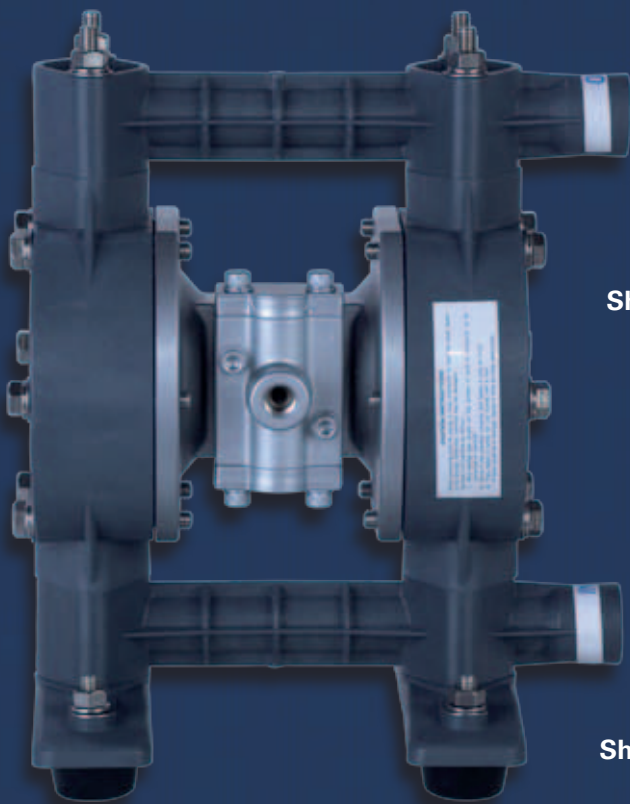

DP-15 Polypropylene
Dimensions:
246 mm W x 297 mm H
Net Wt.: 4,0 kg (9.0 lbs.)
Shipping Wt.: 5,4 kg (12.0 lbs.)

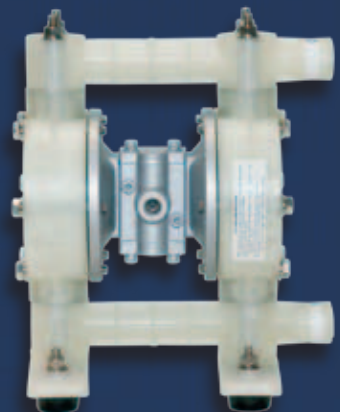

DP Series Specifications

DP-10 Port Dimensions

Intake & discharge connection:

Polypropylene (PPG)	3/8" 10 mm Female Rc
Aluminum (ADC-12)	3/8" 10 mm Female Rc
Stainless Steel (316)	3/8" 10 mm Female Rc

DP-15 Port Dimensions

Intake & discharge connection:

Polypropylene (PPG)	1/2" 15 mm Female Rc
Groundable Acetal	1/2" 15 mm Female Rc

Air Inlet/Exhaust

Air inlet (incl. ball valve):	1/4" 5 mm Female Rc
Air exhaust (incl. silencer):	3/8" 10 mm Female Rc

Maximum Liquid Temperature*

Diaphragm Material	Temperature
Neoprene (CR)	82°C (180°F)
Buna N (NBR)	82°C (180°F)
Hytrel® (TPEE)	120°C (248°F)
Santoprene® (TPO)	100°C (212°F)
Viton® fluoroelastomer (FKM)	120°C (248°F)
Teflon® (PTFE)	100°C (212°F)

* The maximum liquid temperature for metal and Kynar®-fitted pumps is determined by the elastomer (diaphragm material). Polypropylene and Groundable Acetal pumps have a maximum liquid temperature of 82°C (180°F) regardless of diaphragm material.

Air Supply Pressure (All Models)

1,4 – 7 Bar (0,14 – 0,7 MPa) (20 – 100 PSI)

Discharge Volume Per Cycle

DP-10: 76 cc (0.020 US gallons)

DP-15: 93 cc (0.025 US gallons)

Maximum Cycles Per Minute

All diaphragms: 300

Maximum Size Solid

1,0 mm (1/32")

Maximum Dry Suction Lift

All diaphragms: 3 m (10 feet)

Air Motors

Standard: Aluminium

Optional: Teflon®-coated, or Electroless Nickel Plate

Notes: Hytrel®-fitted pumps include Buna-N wetted o-rings. Santoprene®-fitted pumps include EPDM check balls & wetted o-rings.

DP-10 Series Performance Curve

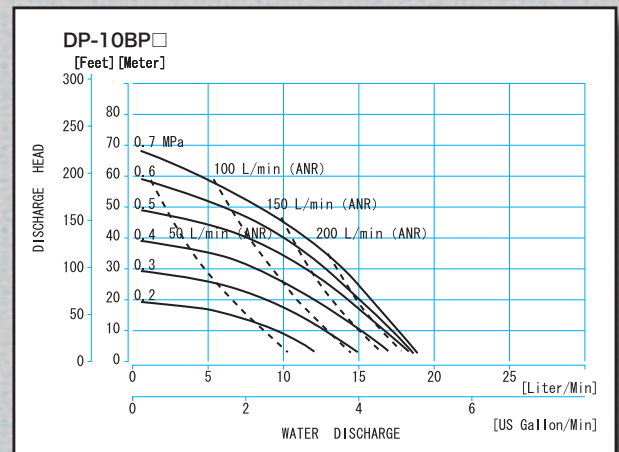

DP-15 Series Performance Curve

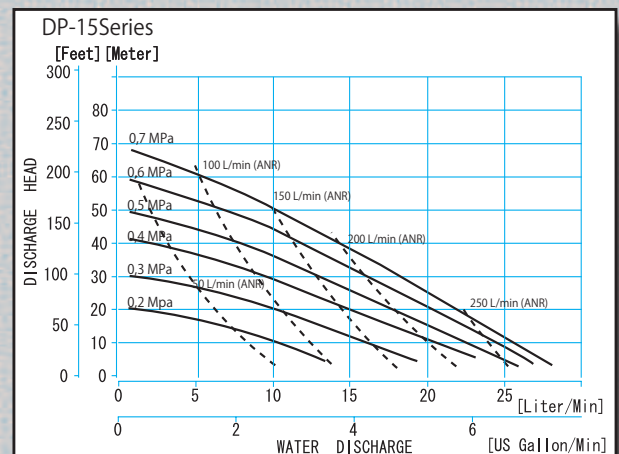

Performance Curves deviate when using PTFE diaphragms

Model Number Nomenclature

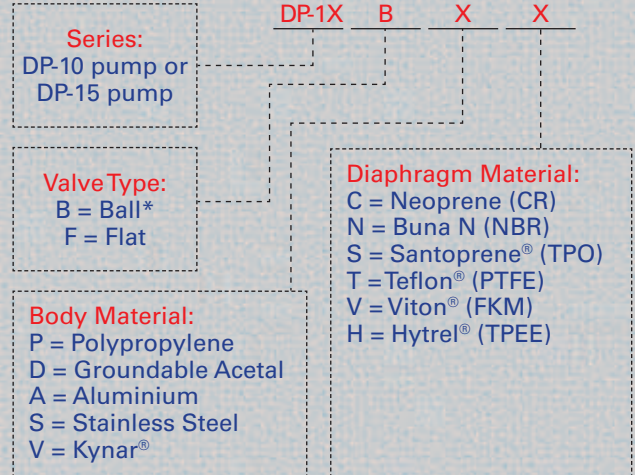

* Ball valves optional for PPG pumps DP-15 only
Additional options listed on page 28.

NDP-10 Series / NDP-15 Series

22 l/m (6 GPM) Maximum Capacity
3/8" (10 mm) Port Size

51 l/m (13.5 GPM) Maximum Capacity
1/2" (15 mm) Port Size



NDP-10 Polypropylene
Dimensions:
185 mm W x 190 mm H
Net Wt.: 2,74 kg (6.1 lbs.)
Shipping Wt.: 3,5 kg (7.7 lbs.)

NDP-15 Polypropylene
Dimensions:
220 mm W x 298 mm H
Net Wt.: 3,5 kg (7.7 lbs.)
Shipping Wt.: 4,3 kg (9.5 lbs.)

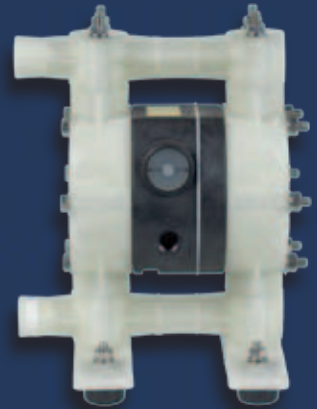

NDP-15 Groundable Acetal
Dimensions:
220 mm W x 298 mm H
Net Wt.: 4,0 kg (9.0 lbs.)
Shipping Wt.: 5,0 kg (11.0 lbs.)



NDP-15 Kynar®
Dimensions:
220 mm W x 298 mm H
Net Wt.: 4,3 kg (9.4 lbs.)
Shipping Wt.: 5,0 kg (11.0 lbs.)

NDP-15 Aluminum
Dimensions:
220 mm W x 272 mm H
Net Wt.: 4,0 kg (9.0 lbs.)
Shipping Wt.: 5,0 kg (11.0 lbs.)



NDP-15 Stainless Steel
Dimensions:
212 mm W x 246,4 mm H
Net Wt.: 6,2 kg (13.6 lbs.)
Shipping Wt.: 7,0 kg (15.5 lbs.)

NDP-10 / NDP-15 Series Specifications

NDP-10 Port Dimensions

Intake & discharge connection:

Polypropylene (PPG) 3/8" 10 mm Female Rc

NDP-15 Port Dimensions

Intake & discharge connection:

Polypropylene (PPG) 1/2" 15 mm Female Rc

Kynar® (PVDF) 1/2" 15 mm Female Rc

Groundable Acetal 1/2" 15 mm Female Rc

Aluminium (ADC-12) 1/2" 15 mm Female Rc

Stainless Steel (316) 1/2" 15 mm Female Rc

Air Inlet/Exhaust

Air inlet (incl. ball valve): 1/4" 5 mm Female Rc

Air exhaust (internal silencer): 3/8" 10 mm Female Rc

Maximum Liquid Temperature*

Diaphragm Material	Temperature
Neoprene (CR)	82°C (180°F)
Buna N (NBR)	82°C (180°F)
Hytrel® (TPEE)	120°C (248°F)
Santoprene® (TPO)	100°C (212°F)
Viton® fluoroelastomer (FKM)	120°C (248°F)
Teflon® (PTFE)	100°C (212°F)

* The maximum liquid temperature for metal and Kynar®-fitted pumps is determined by the elastomer (diaphragm material). Polypropylene and Groundable Acetal pumps have a maximum liquid temperature of 82°C (180°F) regardless of diaphragm material.

Air Supply Pressure (All Models)

1,4 – 7 Bar (0,14 – 0,7 MPa) (20 – 100 PSI)

Discharge Volume Per Cycle

NDP-10: 50 cc (0.013 US gallons)

NDP-15: 128 cc (0.034 US gallons)

Maximum Cycles Per Minute

All diaphragms: 400

Maximum Size Solid

1,0 mm (1/32")

Maximum Dry Suction Lift

NDP-10: All diaphragms: 1,5 m (5 feet)

NDP-15: Flat-type check valve: 2,4 m (8 feet)

Ball-type check valve: 1,5 m (5 feet)

Air Motor

Standard: Ryton® air motor

Notes: Hytrel®-fitted pumps include Buna-N wetted o-rings. Santoprene®-fitted pumps include EPDM check balls & wetted o-rings.

Kynar® (PVDF) pumps fitted with Santoprene®, Hytrel®, or Teflon® include Teflon® o-rings.

Flat valves are standard PTFE.

NDP-10 Series Performance Curve

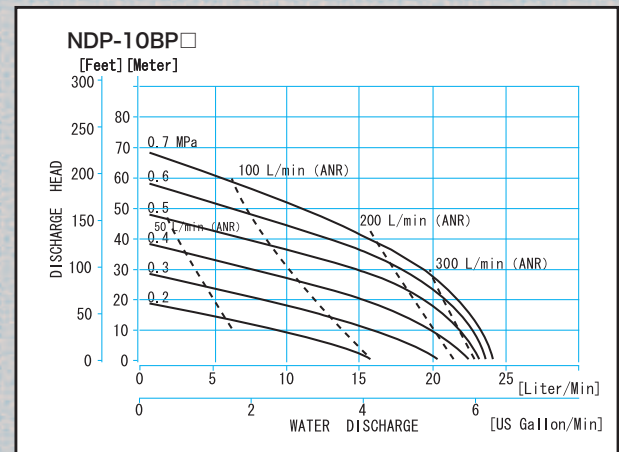

NDP-15 Series Performance Curve

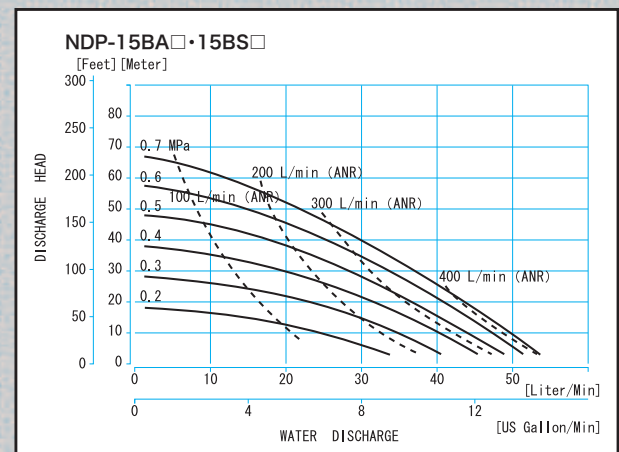

Performance Curves deviate when using PTFE diaphragms

Model Number Nomenclature

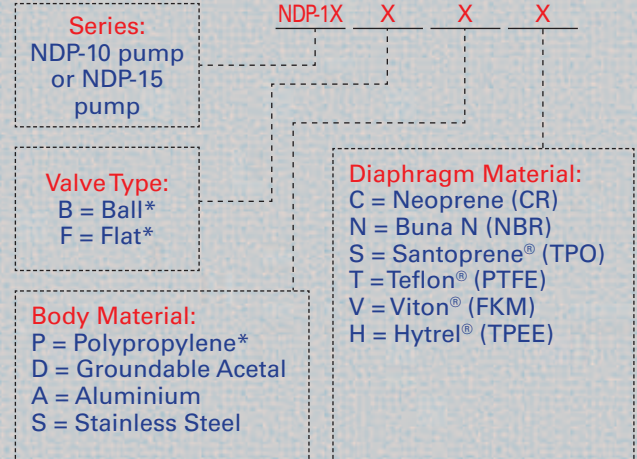

* NDP-10 standard in PPG execution only

* Flat valves standard for NDP-15 Plastic pumps

* Ball valves optional for PPG pumps NDP-15 only

Additional options listed on page 28.

NDP-20 Series

120 l/m (31.7 GPM) Maximum Capacity
3/4" (20 mm) Port Size

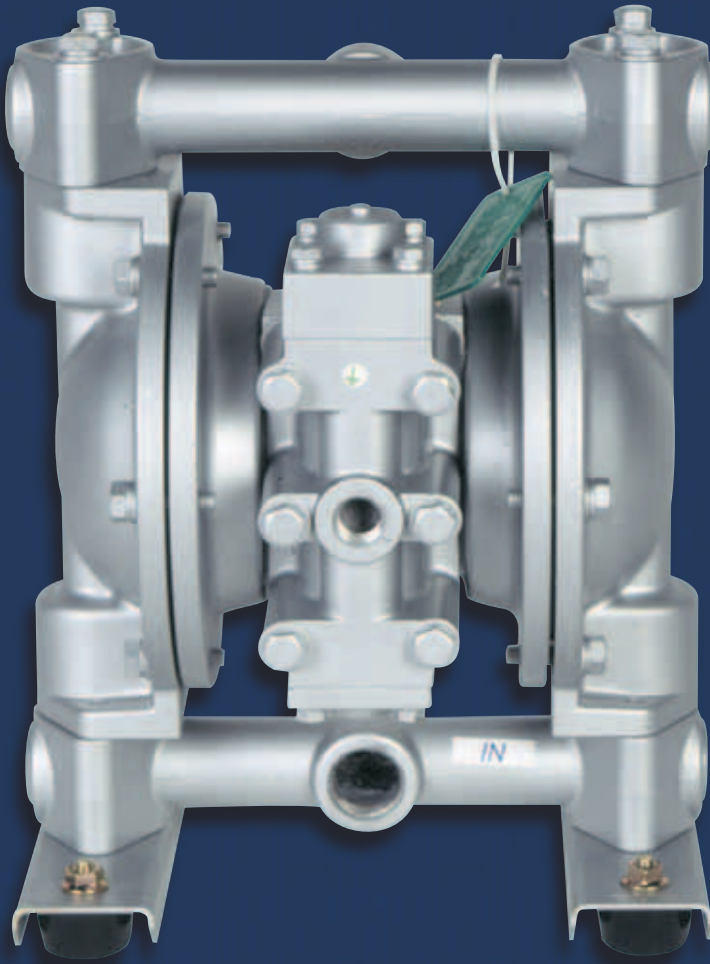

NDP-20 Aluminum
Dimensions:
249 mm W x 320 mm H
Net Wt.: 9,0 kg (19.8 lbs.)
Shipping Wt.:
10,4 kg (23.0 lbs.)

NDP-20 Stainless Steel
Dimensions:
249 mm W x 320 mm H
Net Wt.: 13,9 kg (30.8 lbs.)
Shipping Wt.:
14,5 kg (32.0 lbs.)

Optional: 1" Rc
inlet & outlet
side ports.
Available
for aluminum
pumps only.

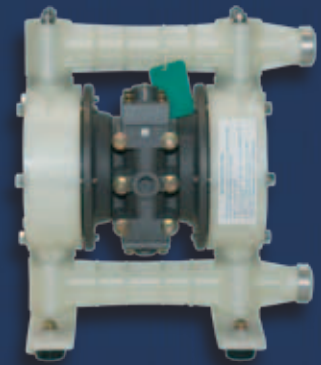

**NDP-20
Polypropylene-Rc**
Dimensions:
316 mm W x 368 mm H
Net Wt.: 8,2 kg (17.6 lbs.)
Shipping Wt.:
10,2 kg (22.6 lbs.)



**NDP-20
Polypropylene-DIN
Flange**
Dimensions:
316 mm W x 375 mm H
Net Wt.: 8,2 kg (17.6 lbs.)
Shipping Wt.:
10,2 kg (22.6 lbs.)

NDP-20 Series Specifications

Port Dimensions

Intake & discharge connection:

Polypropylene (PPG)	3/4" 20 mm Female Rc
Aluminum (ADC-12)	3/4" 20 mm Female Rc
Stainless Steel (316)	3/4" 20 mm Female Rc
Air inlet (incl. ball valve):	3/8" 10 mm Female Rc
Air exhaust (incl. silencer):	3/4" 20 mm Female Rc

DIN & ANSI Flange also available—consult Yamada.

Notes: Flange connections are equivalent to DIN and JIS 10K 20A

Maximum Liquid Temperature*

Diaphragm Material	Temperature
Neoprene (CR)	82°C (180°F)
Buna N (NBR)	82°C (180°F)
Nordel™ (EPDM)	100°C (212°F)
Hytrel® (TPEE)	120°C (248°F)
Santoprene® (TPO)	100°C (212°F)
Viton® fluoroelastomer (FKM)	120°C (248°F)
Teflon® (PTFE)	100°C (212°F)

*The maximum liquid temperature for metal and Kynar®-fitted pumps is determined by the elastomer (diaphragm material). Polypropylene pumps have a maximum liquid temperature of 82°C (180°F) regardless of diaphragm material.

Air Supply Pressure (All Models)

1,4 – 7 Bar (0,14 – 0,7 MPa) (20 – 100 PSI)

Discharge Volume Per Cycle

Rubber diaphragm: 615 cc (0.163 US gallons)
PTFE diaphragm: 539 cc (0.143 US gallons)

Maximum Cycles Per Minute

Rubber diaphragm: 195
PTFE diaphragm: 195

Maximum Size Solid

2,0 mm (1/16")

Maximum Dry Suction Lift

Rubber-fitted pump capability: 5,5 m (18 feet)

Air Motors

Metal pumps standard with aluminium motor
Plastic pumps standard with PPG motor
Optional air motors: Teflon®-coated, Electroless Nickel Plate for aluminium air motor.

Notes: Hytrel®-fitted pumps include Buna-N wetted o-rings. Santoprene®-fitted pumps include EPDM check balls & wetted o-rings.

Metal Pump Performance Curve

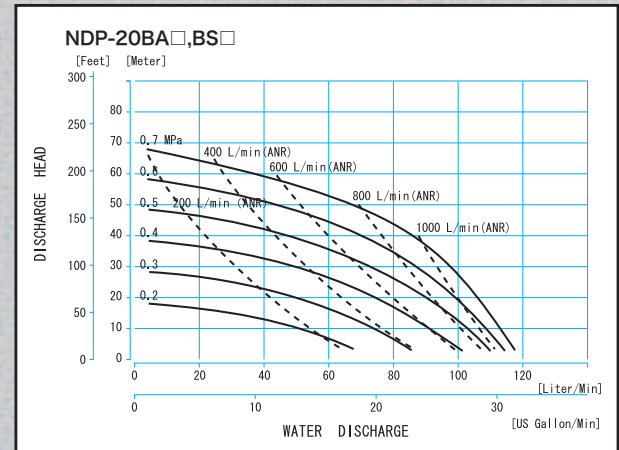

Performance Curves deviate when using PTFE diaphragms

Plastic Pump Performance Curve

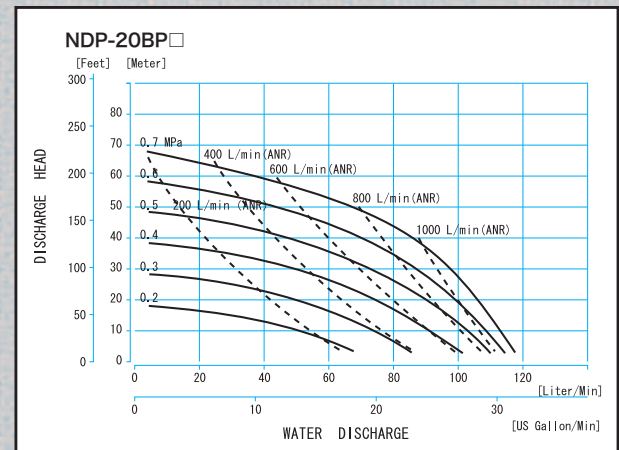

Performance Curves deviate when using PTFE diaphragms

Model Number Nomenclature

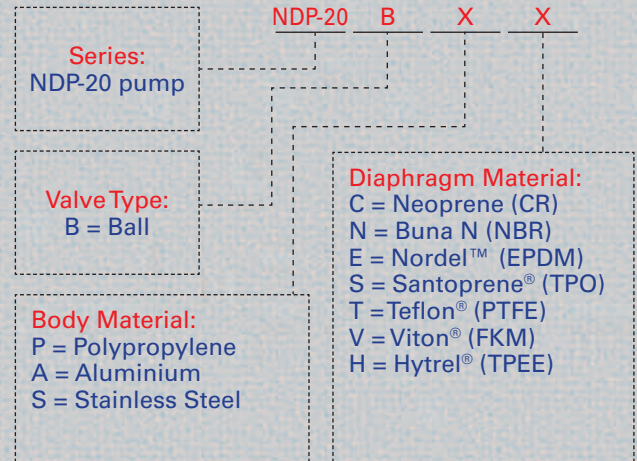

Additional options listed on page 28.

NDP-25 Series

170 l/m (46.2 GPM) Maximum Capacity
1" (25 mm) Port Size

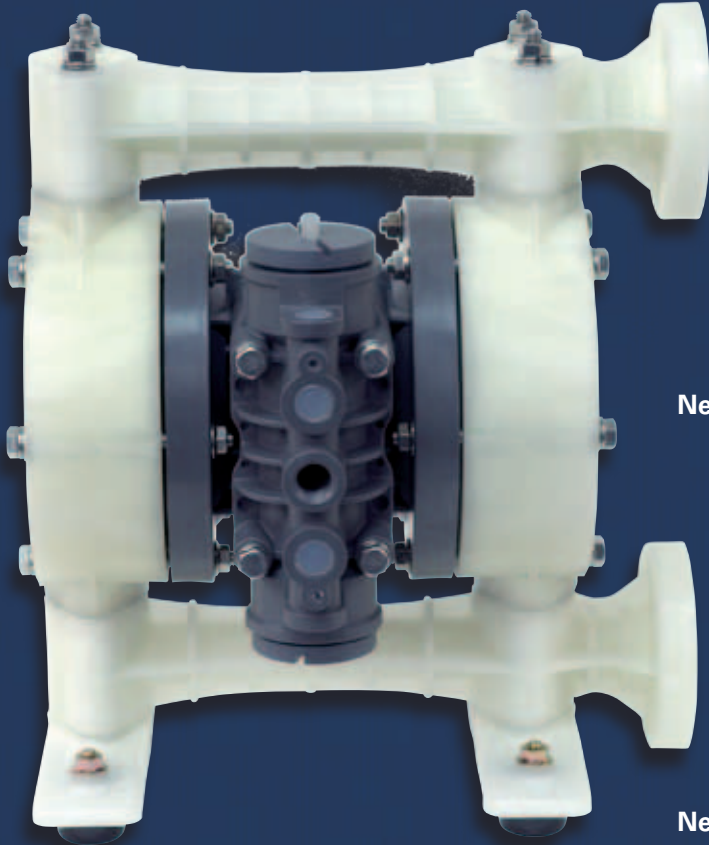

NDP-25 Polypropylene -DIN Flange

Dimensions: 366 mm W x 422 mm H
Net Wt.: 10,9 kg (29.0 lbs.)
Shipping Wt.: 12,6 kg (30.0 lbs.)

NDP-25 Polypropylene -Rc

Dimensions:
366 mm W x 429 mm H
Net Wt.: 10,9 kg (29.0 lbs.)
Shipping Wt.:
12,6 kg (30.0 lbs.)

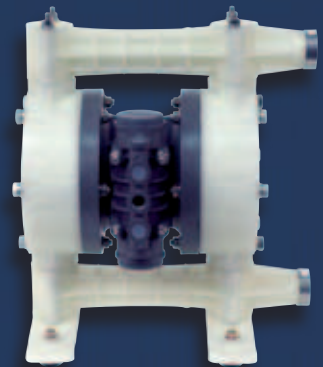

NDP-25 Kynar®-Rc

Dimensions:
366 mm W x 429 mm H
Net Wt.: 13,4 kg (29.7 lbs.)
Shipping Wt.:
15,0 kg (33.0 lbs.)



NDP-25 Kynar®-DIN Flange

Dimensions:
366 mm W x 442 mm H
Net Wt.: 13,4 kg (29.7 lbs.)
Shipping Wt.:
15,0 kg (33.0 lbs.)



NDP-25 Aluminum

Dimensions:
287 mm W x 383 mm H
Net Wt.: 13,0 kg (27.0 lbs.)
Shipping Wt.:
14,0 kg (31.0 lbs.)

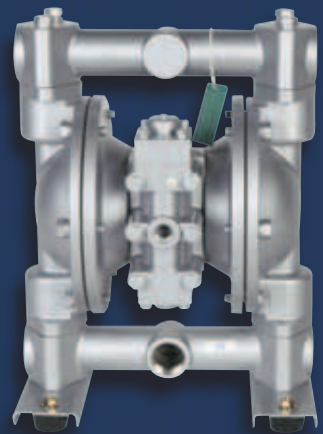

NDP-25 Stainless Steel

Dimensions:
287 mm W x 383 mm H
Net Wt.: 19,9 kg (42.0 lbs.)
Shipping Wt.:
21,0 kg (46.0 lbs.)

NDP-25 Cast Iron

Dimensions:
287 mm W x 383 mm H
Net Wt.: 19,9 kg (43.0 lbs.)
Shipping Wt.:
21,0 kg (46.0 lbs.)

NDP-25 Series Specifications

Port Dimensions

Intake & discharge connection:

Polypropylene (PPG)	1" 25 mm Female Rc
Kynar® (PVDF)	1" 25 mm Female Rc
Aluminum (ADC-12)	1" 25 mm Female Rc
Stainless Steel (316)	1" 25 mm Female Rc
Cast Iron	1" 25 mm Female Rc
Air inlet (incl. ball valve):	3/8" 10 mm Female Rc
Air exhaust (incl. silencer):	3/4" 20 mm Female Rc

DIN & ANSI Flange also available—consult Yamada.

Notes: Flange connections are equivalent to DIN and JIS 10K 25A

Maximum Liquid Temperature*

Diaphragm Material	Temperature
Neoprene (CR)	82°C (180°F)
Buna N (NBR)	82°C (180°F)
Nordel™ (EPDM)	100°C (212°F)
Hytrel® (TPEE)	120°C (248°F)
Santoprene® (TPO)	100°C (212°F)
Viton® fluoroelastomer (FKM)	120°C (248°F)
Teflon® (PTFE)	100°C (212°F)

*The maximum liquid temperature for metal and Kynar®-fitted pumps is determined by the elastomer (diaphragm material). Polypropylene pumps have a maximum liquid temperature of 82°C (180°F) regardless of diaphragm material.

Air Supply Pressure (All Models)

1,4 – 7 Bar (0,14 – 0,7 MPa) (20 – 100 PSI)

Discharge Volume Per Cycle

Rubber diaphragm: 833 cc (0.22 US gallons)

PTFE diaphragm: 787 cc (0.21 US gallons)

Maximum Cycles Per Minute

Rubber diaphragm: 210

PTFE diaphragm: 210

Maximum Size Solid

4,8 mm (3/16")

Maximum Dry Suction Lift

Rubber-fitted pump capability: 5,5 m (18 feet)

Air Motors:

Metal pumps standard with aluminium motor

Plastic pumps standard with PPG motor

Optional air motors: Teflon®-coated, Electroless

Nickel Plate for aluminium air motor.

All Polypropylene, Aluminum, Cast Iron, and SS Hytrel® fitted pumps include Buna-N wetted o-rings. Santoprene® fitted pumps include EPDM check balls & wetted o-rings.

Kynar® (PVDF) pumps fitted with Santoprene®, Hytrel®, or Teflon® include Teflon® check balls & o-rings.

Metal Pump Performance Curve

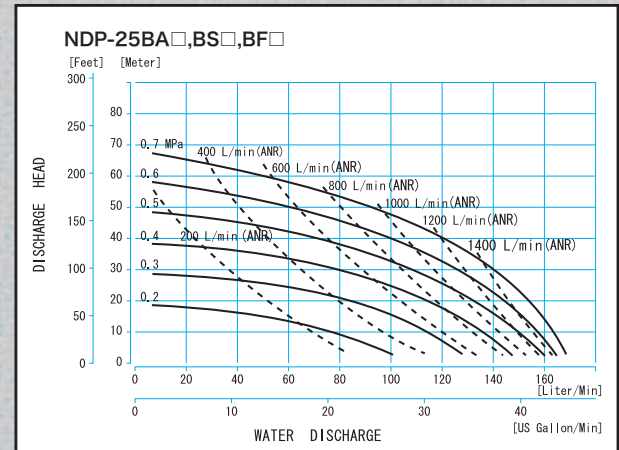

Performance Curves deviate when using PTFE diaphragms

Plastic Pump Performance Curve

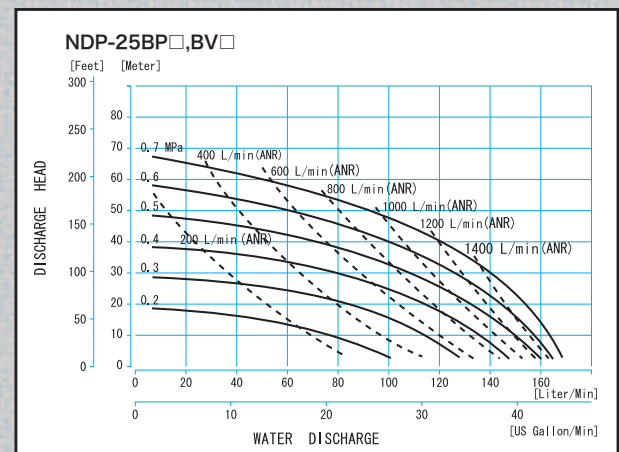

Performance Curves deviate when using PTFE diaphragms

Model Number Nomenclature

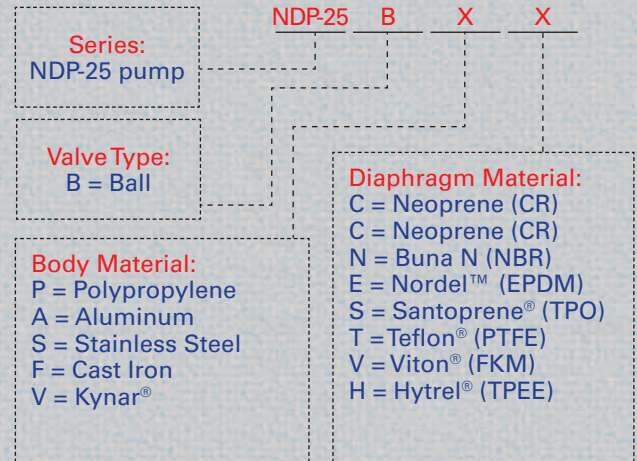

Additional options listed on page 28.

NDP-40 Series

405 l/m (107 GPM) Maximum Capacity
1-1/2" (40 mm) Port Size

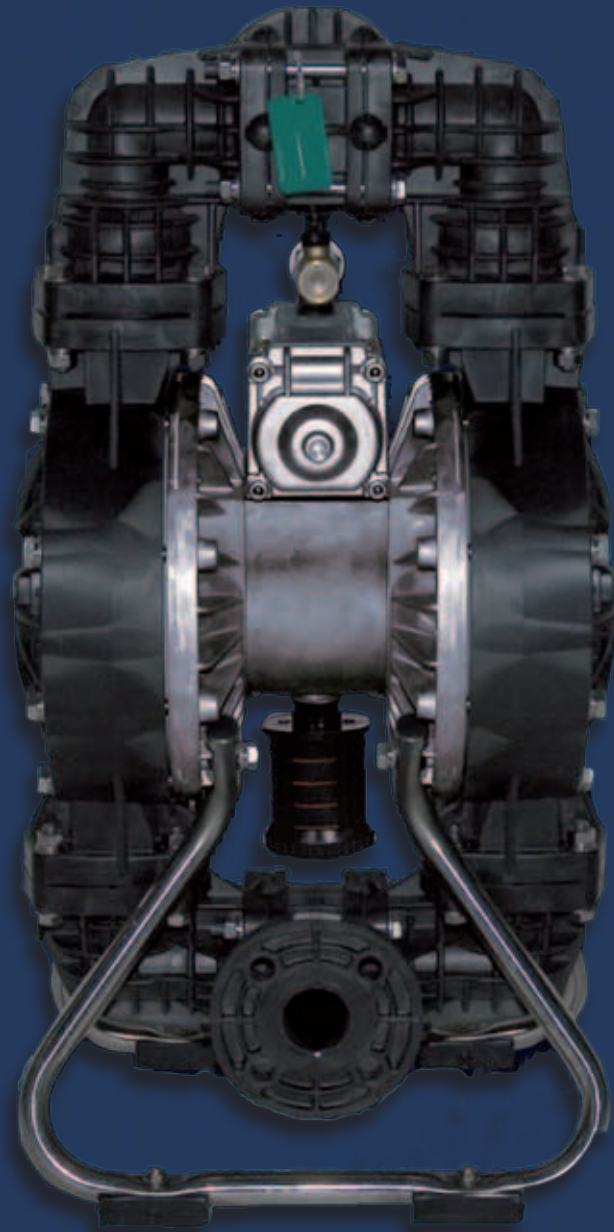

NDP-40 Kynar® (PVDF)
Dimensions:
405 mm W x 752 mm H
Net Wt.: 32,0 kg (71.0 lbs.)
Shipping Wt.: 40,5 kg (89.0 lbs.)

NDP-40 Polypropylene
Dimensions:
405 mm W x 752 mm H
Net Wt.: 27,0 kg (60.0 lbs.)
Shipping Wt.:
35,5 kg (78.0 lbs.)



NDP-40 Stainless Steel
Dimensions:
411 mm W x 705 mm H
Net Wt.: 43,0 kg (95.0 lbs.)
Shipping Wt.:
51,5 kg (114.0 lbs.)



NDP-40 Cast Iron-NPT
Dimensions:
411 mm W x 704 mm H
Net Wt.: 47,0 kg (104.0 lbs.)
Shipping Wt.:
55,5 kg (122.0 lbs.)



*ANSI 150 Flange
available on Stainless Steel
pumps.*

NDP-40 Series Specifications

Port Dimensions

Intake & discharge connection:

Polypropylene (PPG)	1-1/2" 40 mm DN40 PN10
Kynar® (PVDF)	1-1/2" 40 mm DN40 PN10
Aluminum (ADC-12)	1-1/2" 40 mm DN40 PN10
(Combi Flange with tapped 1-1/2" 40 mm Female Rc)	
Stainless Steel (316)	1-1/2" 40 mm DN40 PN10
Cast Iron	1-1/2" 40 mm Female Rc
Air inlet (incl. ball valve):	1/2" 15 mm Female Rc
Air exhaust (incl. silencer):	1" 25 mm Female Rc

Notes: Flange connections are equivalent to DIN and JIS 10K 40A

Maximum Liquid Temperature*

Diaphragm Material	Temperature
Neoprene (CR)	82°C (180°F)
Buna N (NBR)	82°C (180°F)
Nordel™ (EPDM)	100°C (212°F)
Hytrel® (TPEE)	120°C (248°F)
Santoprene® (TPO)	100°C (212°F)
Viton® fluoroelastomer (FKM)	120°C (248°F)
Teflon® (PTFE)	100°C (212°F)

*The maximum liquid temperature for metal and Kynar®-fitted pumps is determined by the elastomer (diaphragm material). Polypropylene pumps have a maximum liquid temperature of 82°C (180°F) regardless of diaphragm material.

Air Supply Pressure (All Models)

1,4 – 7 Bar (0,14 – 0,7 MPa) (20 – 100 PSI)

Discharge Volume Per Cycle

Rubber diaphragm: 2,74 liters (0.73 US gallons)

PTFE diaphragm: 1,40 liters (0.37 US gallons)

Maximum Cycles Per Minute

Rubber diaphragm: 148

PTFE diaphragm: 270

Maximum Size Solid

7,0 mm (9/32")

Maximum Dry Suction Lift

Rubber-fitted pump capability: 5,5 m (18 feet)

Air Motor

Standard: Aluminium

Optional: Teflon®-coated,
or Electroless Nickel Plate

All Polypropylene, Aluminum, Cast Iron, and SS Hytrel® fitted pumps include Buna-N wetted o-rings. Santoprene® fitted pumps include EPDM check balls & wetted o-rings. Kynar® (PVDF) pumps fitted with Santoprene®, Hytrel®, or Teflon® include Teflon® check balls & o-rings.

Metal Pump Performance Curve

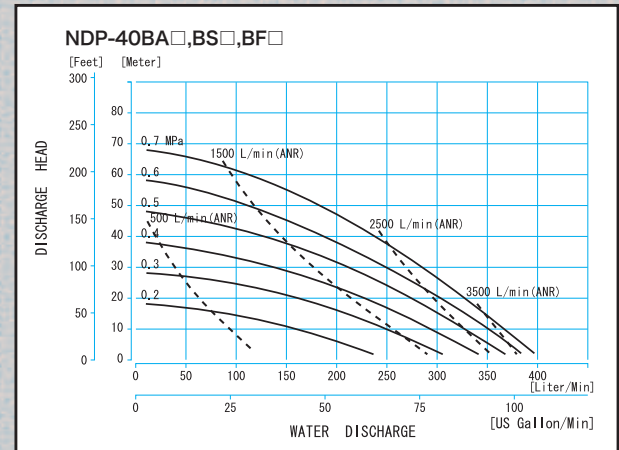

Performance Curves deviate when using PTFE diaphragms

Plastic Pump Performance Curve

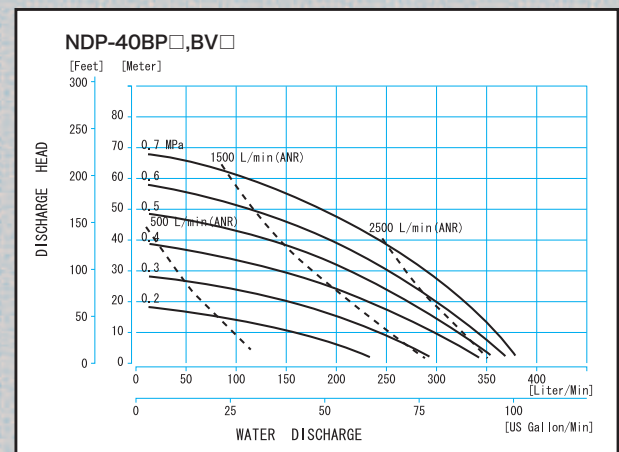

Performance Curves deviate when using PTFE diaphragms

Model Number Nomenclature

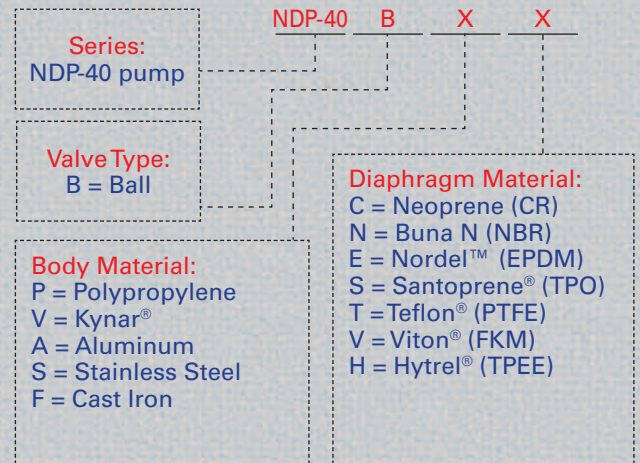

Additional options listed on page 28.

NDP-50 Series

620 l/m (164 GPM) Maximum Capacity
2 Inch (50 mm) Port Size

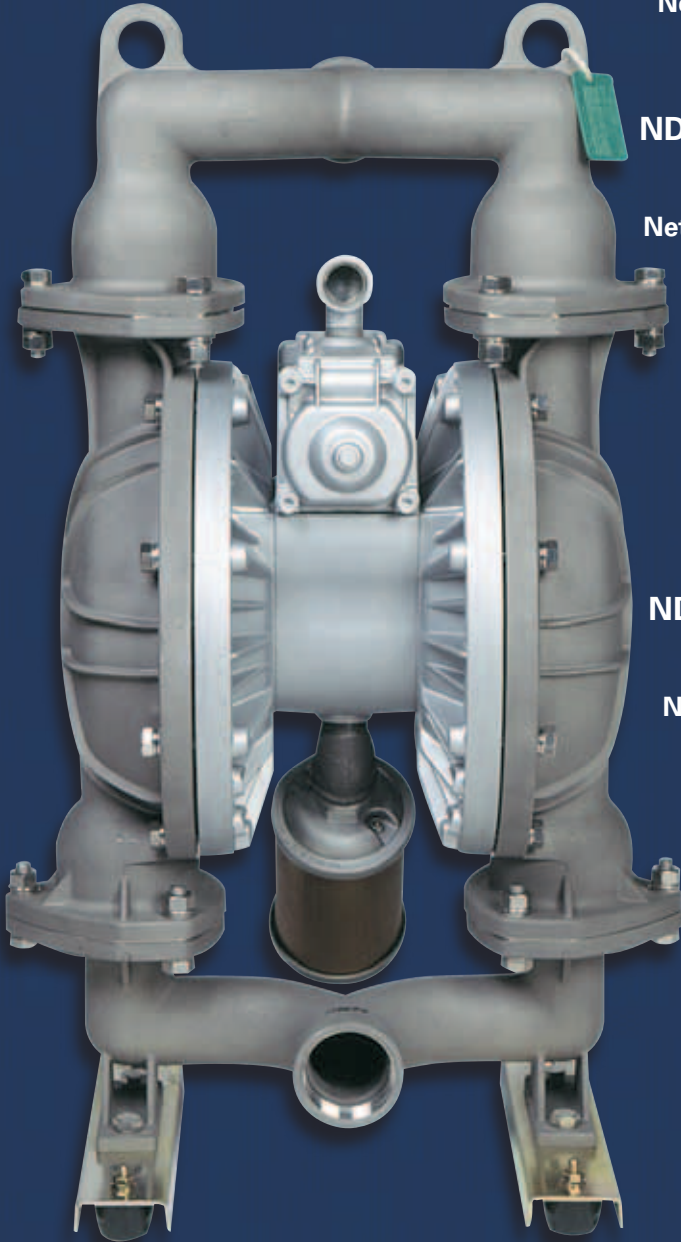

NDP-50 Cast-iron

Dimensions: 450 mm W x 776 mm H
Net Wt.: 64,0 kg (141.0 lbs.)
Shipping Wt.: 76,0 kg (168.0 lbs.)

NDP-50 Aluminum

Dimensions:
452 mm W x 779 mm H
Net Wt.: 36,0 kg (79.0 lbs.)
Shipping Wt.:
48,0 kg (106.0 lbs.)

NDP-50 Stainless Steel

Dimensions:
450 mm W x 782 mm H
Net Wt.: 63,0 kg (139.0 lbs.)
Shipping Wt.:
75,0 kg (165.0 lbs.)

NDP-50 Polypropylene

Dimensions:
472 mm W x 821 mm H
Net Wt.: 37,0 kg (82.0 lbs.)
Shipping Wt.:
49,0 kg (108.0 lbs.)

NDP-50 Kynar® (PVDF)

Dimensions:
472 mm W x 821 mm H
Net Wt.: 42,0 kg (93.0 lbs.)
Shipping Wt.:
54,0 kg (119.0 lbs.)



NDP-50 Series Specifications

Port Dimensions

Intake & discharge connection:

Polypropylene (PPG)	2" 50 mm DN50 PN10
Kynar® (PVDF)	2" 50 mm DN50 PN10
Aluminum (ADC-12)	2" 50 mm DN50 PN10 (Combi Flange with tapped 2" 50 mm Female Rc)
Stainless Steel (316)	2" 50 mm DN50 PN10
Cast Iron	2" 50 mm Female Rc
Air inlet (incl. ball valve):	3/4" 20 mm Female Rc
Air exhaust (incl. silencer):	1" 25 mm Female Rc

Notes: Flange connections are equivalent to DIN and JIS 10K 50A and ANSI 150 2

Maximum Liquid Temperature*

Diaphragm Material	Temperature
Neoprene (CR)	82°C (180°F)
Buna N (NBR)	82°C (180°F)
Nordel™ (EPDM)	100°C (212°F)
Hytrel® (TPEE)	120°C (248°F)
Santoprene® (TPO)	100°C (212°F)
Viton® fluoroelastomer (FKM)	120°C (248°F)
Teflon® (PTFE)	100°C (212°F)

*The maximum liquid temperature for metal and Kynar®-fitted pumps is determined by the elastomer (diaphragm material). Polypropylene pumps have a maximum liquid temperature of 82°C (180°F) regardless of diaphragm material.

Air Supply Pressure (All Models)

1,4 – 7 Bar (0,14 – 0,7 MPa) (20 – 100 PSI)

Discharge Volume Per Cycle

Rubber diaphragm: 4,25 liters (1.12 US gallons)

PTFE diaphragm: 2,61 liters (0.69 US gallons)

Maximum Cycles Per Minute

Rubber diaphragm: 146

PTFE diaphragm: 220

Maximum Size Solid

8,0 mm (5/16")

Maximum Dry Suction Lift

Rubber-fitted pump capability: 5,8 m (19 feet)

Air Motor

Standard: Aluminium

Optional: Teflon®-coated,
or Electroless Nickel Plate

All Polypropylene, Aluminum, Cast Iron, and SS Hytrel® fitted pumps include Buna-N wetted o-rings. Santoprene® fitted pumps include EPDM check balls & wetted o-rings. Kynar® (PVDF) pumps fitted with Santoprene®, Hytrel®, or Teflon® include Teflon® check balls & o-rings.

Metal Pump Performance Curve

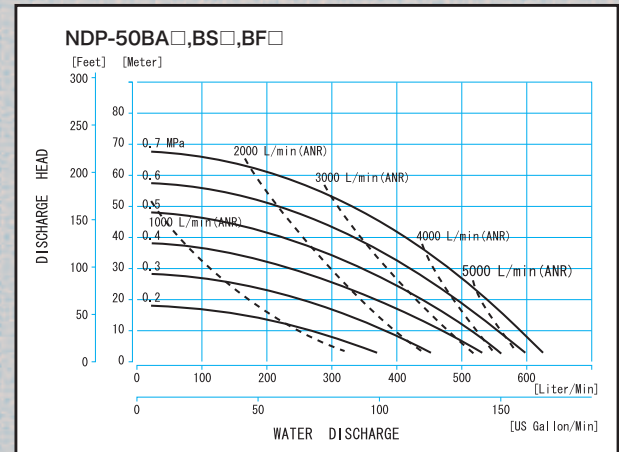

Performance Curves deviate when using PTFE diaphragms

Plastic Pump Performance Curve

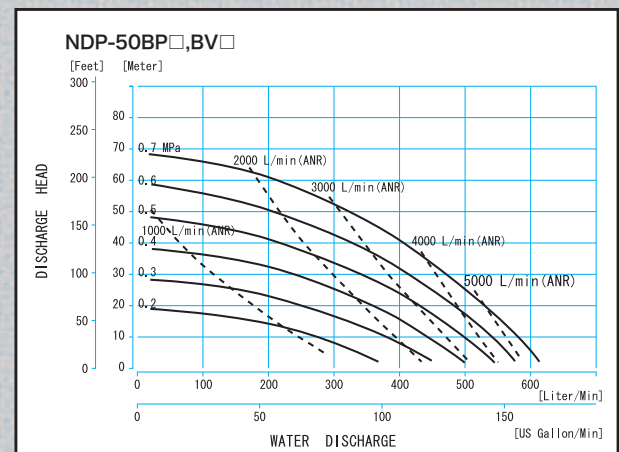

Performance Curves deviate when using PTFE diaphragms

Model Number Nomenclature

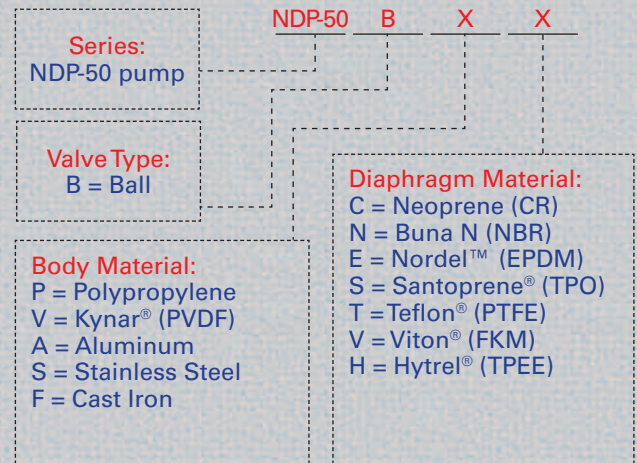

Additional options listed on page 28.

NDP-80 Series

814 l/m (215 GPM) Maximum Capacity
3" (80 mm) Port Size

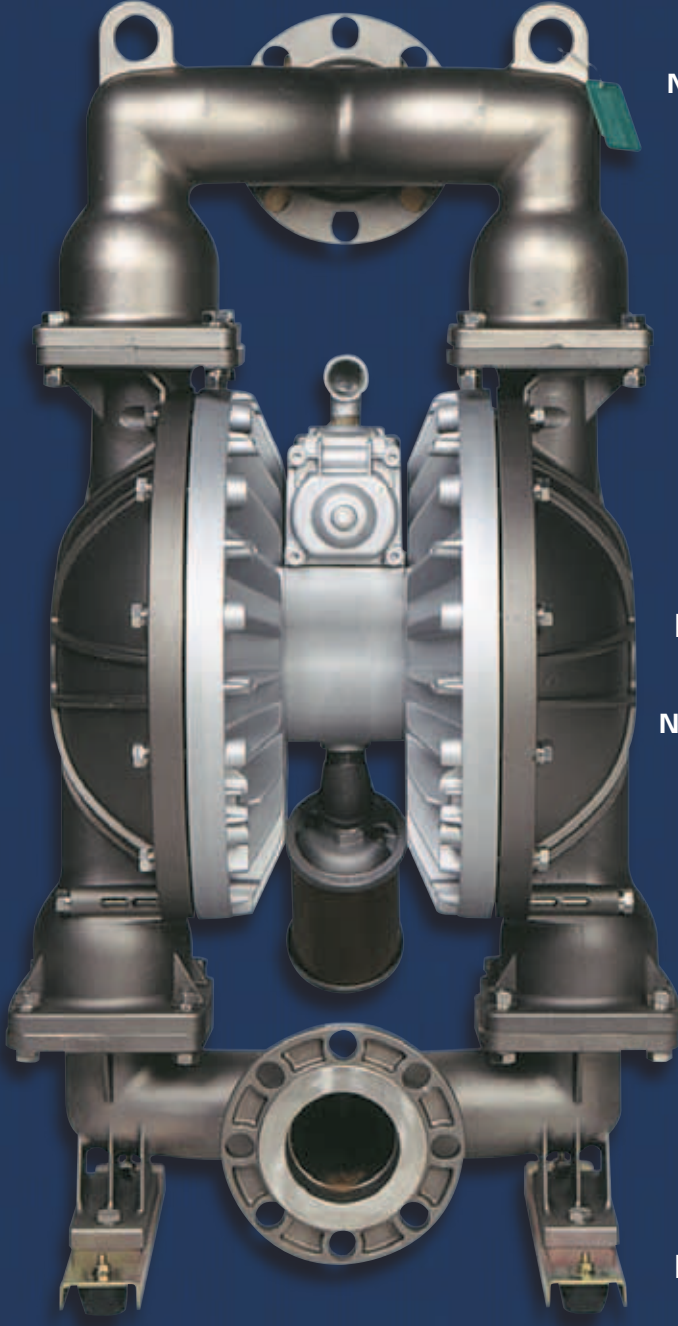

NDP-80 Stainless Steel
Dimensions: 521 mm W x 984 mm H
Net Wt.: 104,0 kg (229.0 lbs.)
Shipping Wt.: 119,0 kg (262.0 lbs.)

NDP-80 Aluminum
Dimensions:
522 mm W x 998 mm H
Net Wt.: 62,0 kg (137,0 lbs.)
Shipping Wt.:
77,0 kg (170.0 lbs.)



NDP-80 Cast Iron-NPT
Dimensions:
521 mm W x 984 mm H
Net Wt.: 110,0 kg (243.0 lbs.)
Shipping Wt.:
125,0 kg (276.0 lbs.)



NDP-80 Polypropylene
Dimensions:
580 mm W x 1044 mm H
Net Wt.: 70,0 kg (154.0 lbs.)
Shipping Wt.:
85,0 kg (187.0 lbs.)

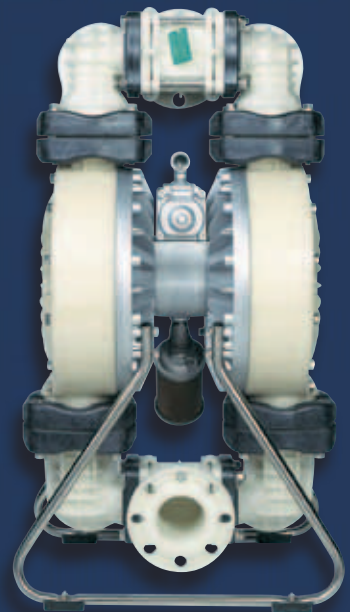

NDP-80 Series Specifications

Port Dimensions

Intake & discharge connection:

Polypropylene (PPG)	3" 80 mm DN 80 PN 10
Aluminum (ADC-12)	3" 80 mm DN 80 PN 10 (Combi Flange with tapped 3" 80 mm Female Rc)
Stainless Steel (316)	3" 80 mm DN 80 PN 10
Cast Iron	3" 80 mm Female Rc
Air inlet (incl. ball valve):	3/4" 20 mm Female Rc
Air exhaust (incl. silencer):	1" 25 mm Female Rc

Notes: Flange connections are equivalent to DIN and JIS 10K 80A and ANSI 150 3

Maximum Liquid Temperature*

Diaphragm Material	Temperature
Neoprene (CR)	82°C (180°F)
Buna N (NBR)	82°C (180°F)
Nordel™ (EPDM)	100°C (212°F)
Hytrel® (TPEE)	120°C (248°F)
Santoprene® (TPO)	100°C (212°F)
Viton® fluoroelastomer (FKM)	120°C (248°F)
Teflon® (PTFE)	100°C (212°F)

*The maximum liquid temperature for metal pumps is determined by the elastomer (diaphragm material). Polypropylene pumps have a maximum liquid temperature of 82°C (180°F) regardless of diaphragm material.

Air Supply Pressure (All Models)

1,4 – 7 Bar (0,14 – 0,7 MPa) (20 – 100 PSI)

Discharge Volume Per Cycle

Rubber diaphragm: 8,57 liters (2.26 US gallons)
PTFE diaphragm: 3,8 liters (1.0 US gallons)

Maximum Cycles Per Minute

Rubber diaphragm: 95
PTFE diaphragm: 160

Maximum Size Solid

10,0 mm (13/32")

Maximum Dry Suction Lift

Rubber-fitted pump capability: 5,8 m (19 feet)

Air Motor

Standard: Aluminium
Optional: Teflon®-coated,
or Electroless Nickel Plate

All Polypropylene, Aluminum, Cast Iron, and SS Hytrel® fitted pumps include Buna-N wetted o-rings. Santoprene® fitted pumps include EPDM check balls & wetted o-rings. Kynar® (PVDF) pumps fitted with Santoprene®, Hytrel®, or Teflon® include Teflon® o-rings.

Metal Pump Performance Curve

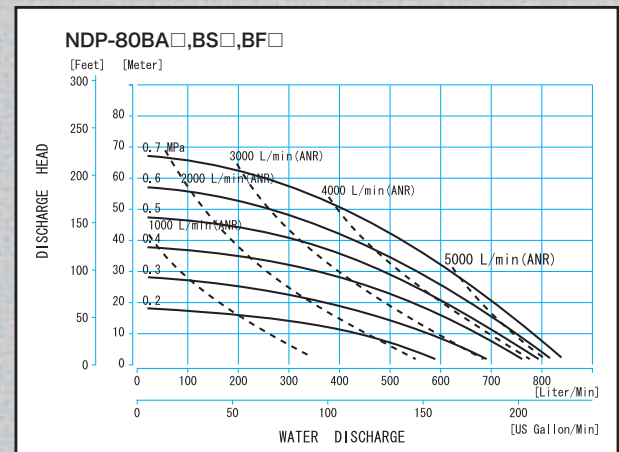

Performance Curves deviate when using PTFE diaphragms

Plastic Pump Performance Curve

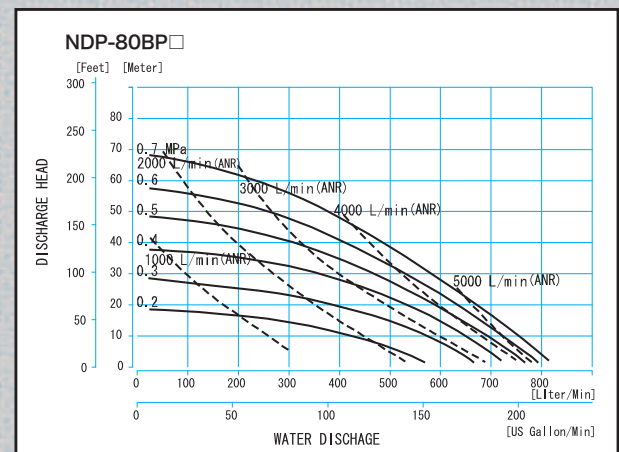

Performance Curves deviate when using PTFE diaphragms

Model Number Nomenclature

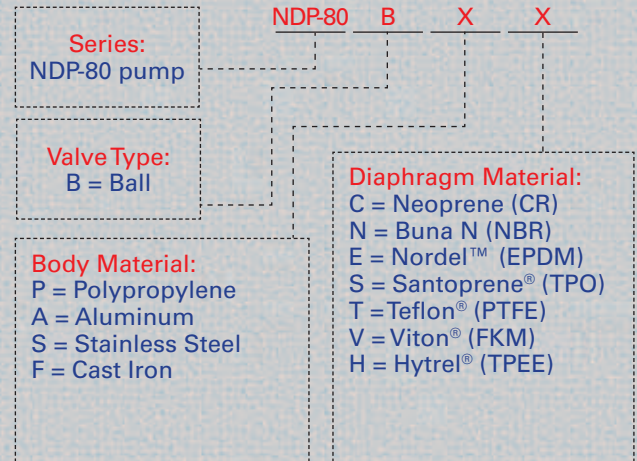

Additional options listed on page 28.

High Pressure 2:1

2:1 Ratio High Pressure Pumps are designed for applications when a maximum 7 Bar operating pressure is insufficient to overcome system requirements.

The flow rate is roughly half of the equivalent size pump output, though a maximum discharge pressure of 13 Bar can be achieved with only 7 Bar air inlet pressure supplied. The 2:1 discharge ratio is achieved by applying air pressure to the surface area of both diaphragms, doubling the discharge output.

Port sizes: 3/4"-3" Capacity: 1 to 378 L/min
Construction Stainless Steel, Cast Iron
or Aluminum wetted materials

Controls: No elaborate bypass, relief valves, or complicated controls required. Excellent pressure retention.

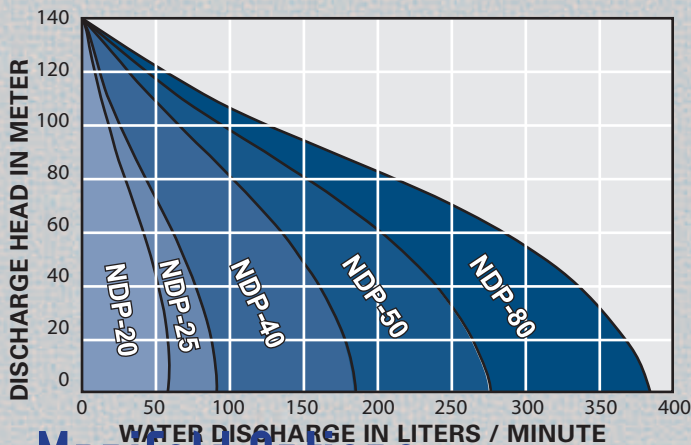

Manifold Options

Many Yamada pumps come with a variety of multi manifold options offering the user various process solutions. Some options available are 2 in 1 out, 2 in 2 out, 1 in 2 out, vertical middle or side inlets etc. For more information on manifold options please contact Yamada or your local distributor.

Port sizes 1/4", 3/8", 1/2", 3/4", and 1"

Construction Polypropylene,
Aluminum, or Stainless Steel

Diaphragm Choice of seven elastomers

Modes of operation Dual suction with
dual or single discharge
single suction with dual discharge

Also mid connection is available for PPG 05 and 15 pumps.

Additional options listed on page 28.



Model NDP-40 HP

Model NDP-25 HP

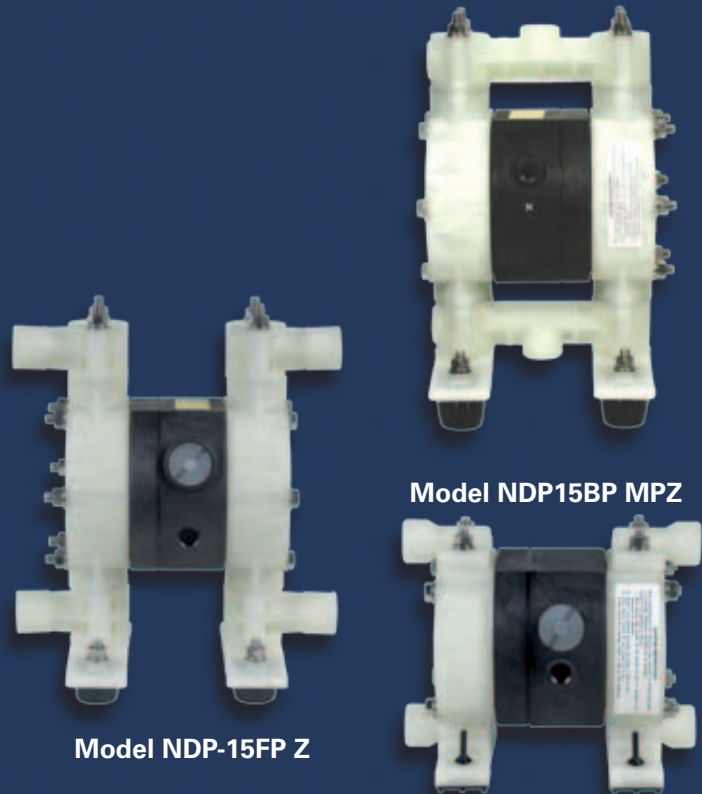

Model NDP-15FP Z

Model NDP15BP MPZ

Model NDP-05FPT Z



XDP Series Pump

XDP Series

The Xtreme Duty Pro™ XDP is designed for use in process type applications including filter press, high pressure, extended deadheading, long runs of discharge pipe and where air consumption is critical.

Air power is conserved by actuating the air valve using a mechanical linkage instead of relying on air pressure. Air power is reduced by 20% vs. a standard air-actuated valve providing more pressure to drive the diaphragm assembly.

Available in 1-1/2", 2" and 3" port sizes, these pumps are built on the liquid platform of a standard NDP Series pump, but with the world's only mechanically-actuated air motor.

Xtreme Duty Pro™ XDP pumps are capable of running on air pressure equivalents as high as 9 Bar or as low as 0,4 Bar and provide the same liquid side performance as the NDP Series pumps.

For additional information, product literature, and drawings please visit www.yamada-europe.com or contact your local Yamada distributor.

Powder Pumps

Yamada Powder Pumps are designed to move bulk powders more effectively throughout your process vs. other unsafe and labor intensive means. These heavy duty pumps will consistently transfer fine-grained, low-bulk density dry powders in a dust-free operation.

Port sizes 1-1/2", 2", or 3"

Construction	Aluminum, Cast Iron, or Stainless Steel
--------------	---

Three series of pumps are offered.

Series BH-1

- Vacuum Activated Aeration Valve mounted to suction manifold.

Series BH-2

- Includes all features of the BH-1.
- Compressed air induction system fluidizes all four check valves while the pump is operating.

Series BH-3

- Includes all features of the BH-1 and BH2.
- Independent port for inert gas fluidization rather than compressed air.
- Delay timer to begin fluidizing check valves 1-60 seconds prior to the pump starting and 1-60 seconds after the pump stops.

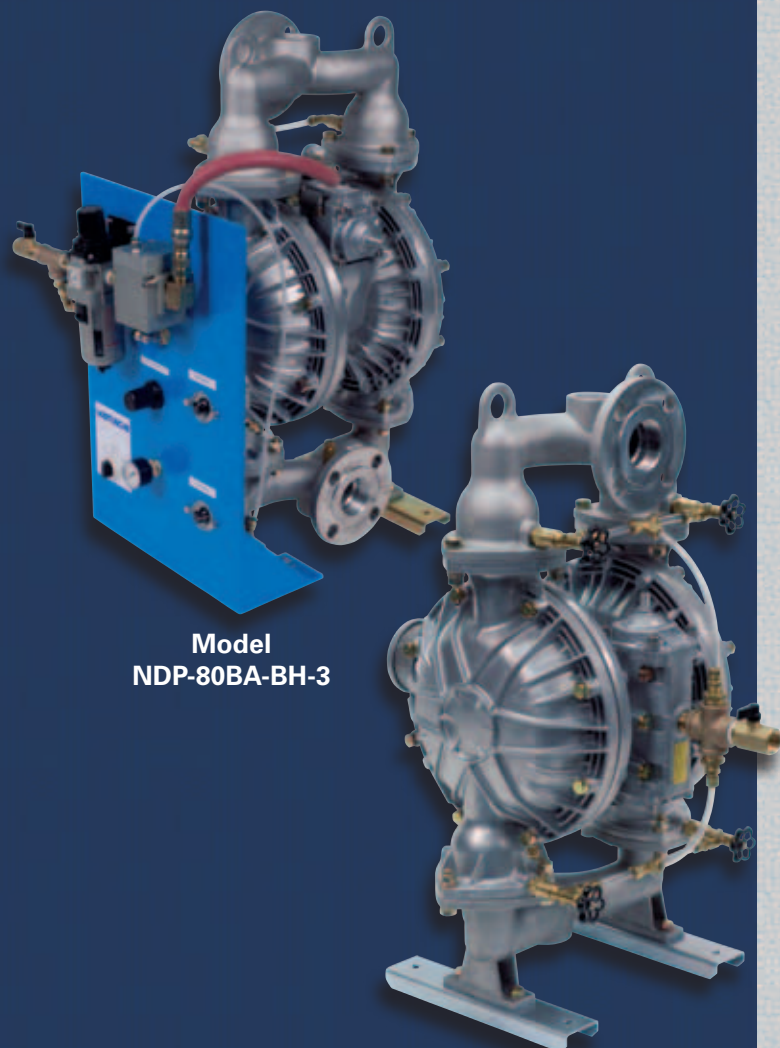

Model NDP-80BA-BH-3

Model NDP-50BA-BH-2

Drum Pumps

Yamada AODD Pumps have distinct design advantages, making them versatile and cost effective drum pumps.

Models are available in Polypropylene, PVDF (Kynar®), Aluminum, and Stainless Steel.

Drum pumps are available in 3/8", 1/2", and 3/4" port sizes. (3/8" metal only & 1/2" plastic only) with flow rates up to 105 l/m.

Refer to DP-10, NDP-15 & NDP-20 technical information for additional performance data. Use applicable NDP nomenclature adding a "D" at the end of the model number. Other sizes and materials are available, consult Yamada.

Port Dimensions

Intake & discharge connection:

Aluminum (ADC-12) 3/8" or 3/4" Female Rc

Includes Aluminum Male Rc

Bung adapter and suction pipe

Stainless Steel (316) 3/8" or 3/4" Female Rc

Includes Stainless Steel Male Rc

Bung adapter and suction pipe

Polypropylene (PPG) 1/2" or 3/4" Female Rc

Includes PVC suction pipe, elbow, & Bung adapter (PPG also avail.)

Note: Yamada recommends utilizing flat-type check valves for the NDP-15 series polypropylene pumps.

Kynar® (PVDF) 1/2" Female Rc

Includes PVDF suction pipe, elbow, and Bung adapter

Drum inlet connection 2" Bung

NDP-32 Serie

The NDP-32 series is a compact, lightweight and easily portable pump with a 1-1/2" liquid inlet and a 1-1/4" vertical outlet. This model corresponds in both footprint dimensions, body size and outlet positions to many pumps used in the marine, oil & gas and mining applications throughout the world. This size pump is often used for waste water or sump / mine dewatering applications and has the ability to pump solid laden slurry solutions. The body is in aluminium with Buna-N diaphragms however can also be prepared with other materials if required. Due to the dimensional standardization it is possible to carryout hard piped pump changeovers without having to modify the piping or system configuration.

Pump model is available in aluminum

Inlet 1-1/2" NPT Outlet 1-1/4" NPT

Air supply pressure 1,4 – 7 Bar

Drum Pumps
3/8", 1/2", & 3/4"
Port Sizes



FDA-Compliant Drum Pumps are available.
Please consult the factory for details.

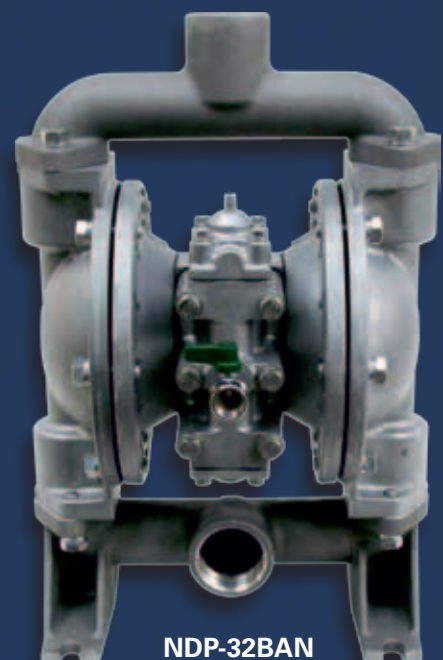

NDP-32BAN

FDA Compliant Pumps

Yamada FDA compliant pumps are specifically designed for Food, Pharmaceutical & Cosmetic industries where 3A or USDA standards are not required.

Pumps include 316 Stainless Steel wetted components with passivated satin finish, epoxy-coated air motor, sanitary clamp fittings, and FDA compliant elastomers: Hytrel®, EPDM and PTFE.

Available in eight sizes from 3/4" to 4" ports with flow ranges from 1–215 gallons per minute.

Note: FDA Series pumps are constructed with oversized sanitary ports



FDA Compliant
316 Stainless Steel

DM(X) Series

Yamada's range of DM(X), (direct mount) electric controlled pumps are specially designed for process applications requiring metering, batching, or variable of constant flow control. These pumps offer extreme operation reliability and parts life time and are well suited to intense process applications. All DM(X) pumps are operated through a locally positioned or remote PLC device (sold separately) and are available in both standard (DM) and EX (DMX) versions.

Some of the benefits of the DM series are; a reduction in pulsation, more accurate flow control and measurement, extended life expectancy of moving parts including diaphragms, unmatched start stop (on off) reliability, remote monitoring and control, variable pump speeds.

DM(X) pumps can be operated with a sensor (recommended) or through a timer control system. Pumps come complete with a electric control cable and air fittings. Yamada DM(X) pumps come in various sizes and are available in a whole range of body and diaphragm materials.

For more information on the Yamada DM(X) series please contact Yamada or your local distributor.

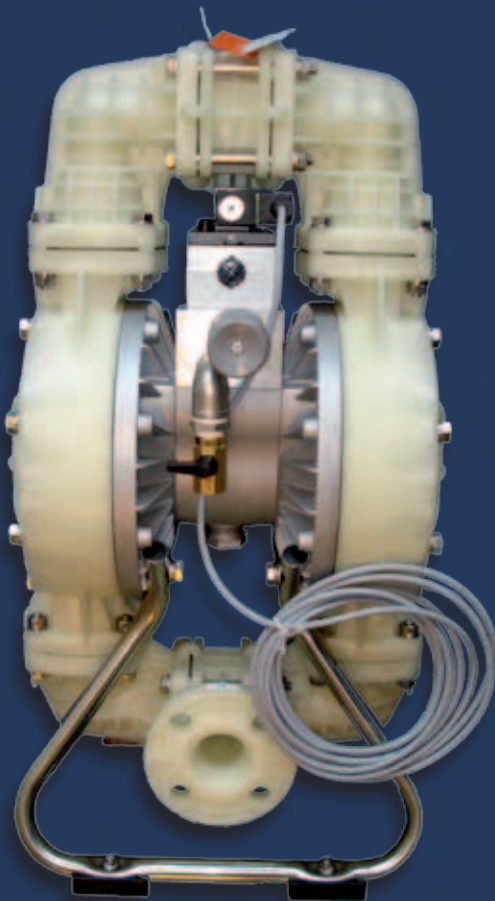

DM(X) Series

Solids Handling Pump

Flap Valve Pump designed to pump large solids

The New Yamada Flap Valve Pump was designed and engineered to address the problems normally associated with flap valve pumps. I.e. Normally due to severe working conditions, there is often a need to remove a pump from service for repairs, cleaning or parts changeovers.

Based on Yamada field proven NDP series foundation, this pump has all of the features and benefits associated with every Yamada pump.

Ingenious Flap Valve design allows for passage of large solids up to 50 mm

Easy access to valve chambers allows easy maintenance when you need it most without the need to remove the pump from service.

Vented diaphragm chambers serve to alleviate problems associated with trapped air/gas.

Features and Benefits

- Repair/clean in place design enables quick servicing of pump
- Up to 50 mm solids handling
- Vent ports to alleviate build-up of air/gas in liquid chamber
- Quick removable flap valves
- Top suction, bottom discharge design will not allow solids to settle in pump.
- Fully non lubricated Air-Valve
- Fully bolted construction
- Short stroke design to help improve diaphragm life.
- Outside-Accessible Air Valve
- Modular Pilot valve design
- No dynamic O-rings to replace or repair.

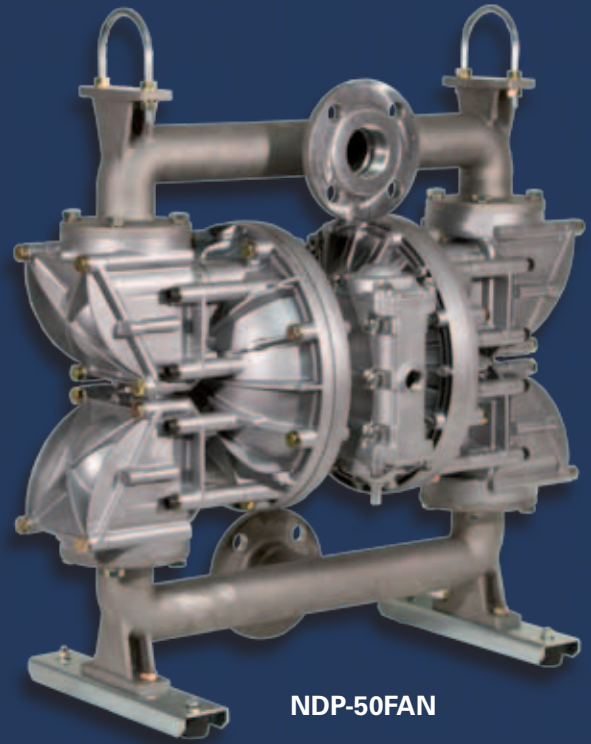

NDP-50FAN



Repair/clean in place design



Only 4 bolts to access flap valves



Modular Heavy Duty Flap Check Valves



Vent ports to alleviate vapour lock and help with priming

Liquid Level Controller



The Yamada LLC-2Y Liquid Level Controller is a totally pneumatic system designed to automatically start and stop Yamada Air-Powered Double Diaphragm Pumps when the liquid level within a tank, sump, etc. reaches predetermined levels. An extremely versatile controller, the LLC-2Y can be used in both single and dual pump applications with any size or model Yamada pump. Used in a single pump configuration, it automatically controls either the filling or emptying of a tank or other vessel. When connected to two separate pumps, it will control both the filling and emptying of the tank. This dual pump capability is particularly useful for waste water storage, contaminated water clean up, and other applications where liquids are regularly transferred into and out of a single vessel.

The LLC-2Y consists of a sophisticated air logic control valve housed in an impact-resistant fiberglass reinforced plastic enclosure. As the liquid level within the tank rises or falls, the subtle changes in pressure are transmitted through high and low level dip tubes to the air logic control valve. When the liquid level reaches a predetermined level (tubing is cut in the field to the preferred HIGH and LOW level points), the power valve supplying air pressure to the pump is turned ON or OFF as required.

The LLC-2Y is capable of maintaining liquid levels in virtually any unpressurized vessel. Its liquid level control span ranges from a few inches to dozens of feet. For added convenience, it may be mounted up to 6 meter away from the pump.

Dry-Run Detection

DRD-100 Dry-Run Detection

DRD-100 Dry-Run Detector

The Yamada DRD-100 detects increases in air volume due to loss of prime or dry-running, and automatically shuts down the pump to prevent excess cycling and increased diaphragm wear.

Extends life of diaphragm

Eliminate air consumption in dry run applications

Prevents air valve from premature failure

Intrinsically safe operation

Supports remote warning systems



Pulsation Dampeners

AD Series

Metering/Injection/Dosing

Equalizes discharge pressure spikes, increasing accuracy.

Filter Press/Inline Filters

Increases filter efficiency and life by providing a smooth flow.

Spraying: Smooth, consistent spray pattern.

Filling

Eliminates inconsistent filling and splashing.

Transfer

Eliminates harmful water hammer, preventing pipe and valve damage.

Yamada Pulsation Dampeners incorporate a flow-through design which keeps solids in suspension, maintaining dampener effectiveness.

A completely automatic air motor self-relieves if reduction of discharge head condition occurs.

Port Sizes: 3/8", 1", 1-1/2", and 2"

Dampener Model	Fits Pump Models
AD-10 (3/8" port)	NDP-5, DP-10/15, & NDP-15
AD-25 (1" port)	NDP-20 & NDP-25
AD-40 (1-1/2" port)	NDP-40
AD-50 (2" port)	NDP-50 & NDP-80

Material

Aluminum (ADC-12)	All models
Stainless Steel (316)	All models
Cast Iron	AD-25, AD-40, & AD-50
Polypropylene (PPG)	All models
Kynar® (PVDF)	AD-25 & AD-50

Diaphragm

Choice of seven elastomers

Air Side Coating Options

Teflon®, or E-Nickel plate air-side

For additional information, product literature, please visit www.yamada-europe.com or contact your local Yamada distributor.

Model AD-25



Model AD-10



Model AD-40



Model AD-50

PSI Without Pulsation Dampener

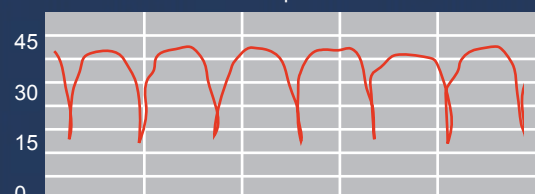

PSI With Pulsation Dampener

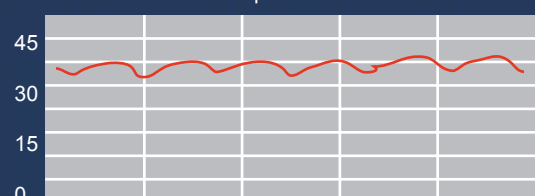



Rubber Compounds

Neoprene (CR)

Excellent for non-corrosive abrasive applications.

Identification: Dull Black with No Dot
Temperature Range: -18°C to 82°C

Buna-N (NBR)

Excellent for petroleum based fluids.

Identification: Black with a Red or Pink Dot
Temperature Range: -12°C to 82°C

Nordel™ (EPDM)

Excellent for low temperatures, caustics and some acids.

FDA Compliant Material (must be specified).

Identification: Black with Green Dot
Temperature Range: -40°C to 100°C

Viton® (FKM)

Excellent for aggressive fluids and high temperature applications.

Identification: Black with Silver or Blue Dot
Temperature Range: -29°C to 120°C



E-Nickel Plating

Teflon® Coating

Pump Diaphragms

What to Consider When Selecting the Proper Diaphragm Material

- Chemical resistance
- Cost
- Estimated flex life
- Temperature limitations
- Abrasion resistance

Thermoplastic Compounds

Hytrel® (TPEE)

Excellent general-purpose diaphragm for non-corrosive abrasive applications and high-flex life. FDA compliant material.

Identification: Tan/Cream material with No Dot

Temperature Range: -18°C to 120°C

Santoprene® (TPO)

Excellent for acids or caustics with a very high flex life.

Identification: Black Thermoplastic

Temperature Range: -23°C to 100°C

Teflon® (PTFE)

Excellent choice for pumping highly aggressive fluids, including solvents.

Identification: White diaphragm with No Dot

Temperature Range: 4,5°C to 100°C

■ Please note that excessive inlet pressure or excessive suction lift can shorten diaphragm life. Please consult Yamada for further information.

Optional Coatings Aluminium Air Motors

Teflon® coating and E-Nickel plating is available for Yamada pumps for two primary reasons:

Environment: Pump installation in a chemically aggressive location where material or fumes not compatible with Aluminum may contact the air motor; or

Diaphragm Failure: If properly selected, the coating or plating will defend the major Aluminum air valve components from the fluid being pumped.

For internal and external protection, the four major air motor components are independently coated or plated then assembled.

Additional Options

Model Number Nomenclature

XXX XX X X X X X

NDP – PUMP SERIES

DP – PUMP SERIES
10 & 15 ONLY

CONNECTION SIZE

CHECK VALVE TYPE

BODY MATERIAL

DIAPHRAGM
MATERIAL

Optional Ball Valve / Seat Materials

- C: Neoprene (CR)
- N: Buna N (NBR)
- E: Nordel™ (EPDM)
- T: Teflon® (PTFE)
- V: Viton® (FKM)
- S: Santoprene® (TPO)
- S1: 316 SS Ball
- S2: 316 SS Seat (Machined)
- S3: 316 SS Ball Guide
- SS: 316 SS Ball & Seat

To properly specify a Yamada Pump, the following information is required.

- Material to be pumped (viscosity and specific gravity)
- Pumping temperature (°C or °F)
- Capacity and operating condition
- Discharge pressure (Bar, PSI)
- Corrosive and/or abrasive?
- Suction line details
- Available air supply

A complete specification form and pump selector is available.

AutoCad® is a registered trademark of Autodesk, Inc.

Hytrel® is a registered trademark of E.I. du Pont de Nemours and Company.

Kynar® is a registered trademark of Arkema.

Nordel™ is a registered trademark of Dupont Dow Elastomers.

Ryton® is a registered trademark of Chevron Phillips Chemical Company.

Santoprene® is a registered trademark of Monsanto Co.

Swagelock® & VCR are trademarks of the Swagelok Companies.

Teflon® is a registered trademark of E.I. du Pont de Nemours and Company.

Viton® is a registered trademark of Dupont Performance Elastomers

Additional Options

Connection Options

- I: Split Suction Manifold
- O: Split Discharge Manifold
- Z: Both Manifolds Split
- MPI: Mid Suction Manifold PPG 05/15
- MPO: Mid Discharge Manifold PPG 05/15
- MPZ: Both Manifolds Mid PPG 05/15
- FLG: Flanged Manifold
- NPT: NPT Female Thread
- CR: BSPT Flange Adapter 40/50/80

Air Motor Options

- PP: Polypropylene Motor Size 20/25
- X2: Nickel Plated Air Motor
- XS: PTFE Coated Motor
- HD: Xtreme Duty Pro Air Motor (40/50/80)

Electric Control Options

- P2: Proximity Sensor 24 – 240 VAC
- PX: Proximity Sensor ATEX (till NDP-25)
- DM: Direct Mount Solenoid Valve
- DMX: Direct Mount Solenoid Valve ATEX
- DMB: Direct Mount Body (Only 20/25)
- DMBX: Direct Mount Body ATEX (Only 20/25)
- RM: Solenoid Valve On/Off
- RMX: Solenoid Valve ATEX On/Off
- Q: Diaphragm Rupture / Leak Sensor Kit

Special Pumps

- A: ATEX Pumps
- BH-1: Powder Pump Series 1
- BH-2: Powder Pump Series 2
- BH-3: Powder Pump Series 3
- HP: 2:1 High Pressure Pump, Metal Only
- D: Drum Pump (10/15/20/25 Series)
- FDA: FDA Compliant
- EP-20RA: 20RA Electro Polished Finish (Only 05/10/15/20.25 SS)

Accessories

- U: High Performance Muffler
- J: Speed Control Muffler
- L: Destroke NDP-20 Through NDP-80
- K: 316 SS Pilot Valve Seats (20/25 Series)
- AP: Abrasion Pad

Additional Options

Ideal Air-Powered Double Diaphragm Pump Installation

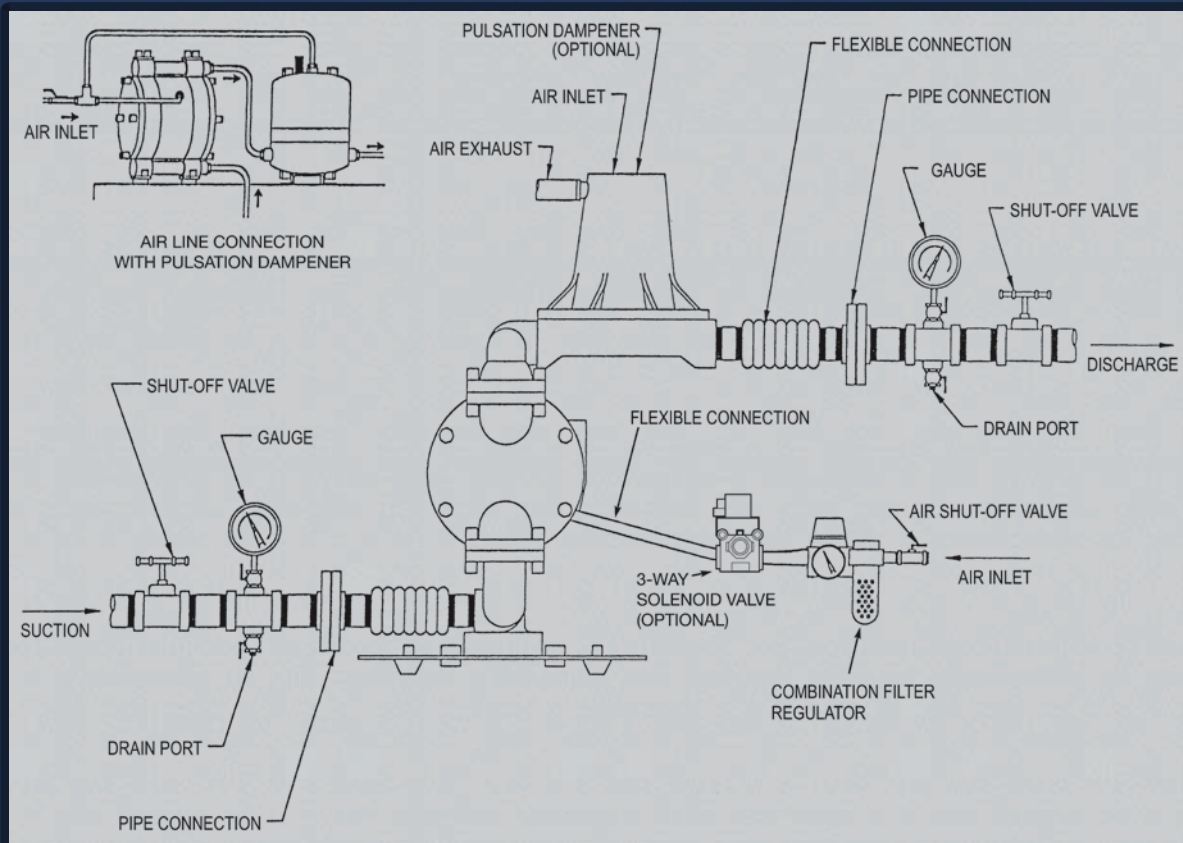

Understanding Performance Curves

To determine compressed air requirements and proper size for a Yamada Air-powered Double Diaphragm Pump, two elements of information are required:

1. **Required Flow Rate (l/m or GPM)**
2. **Total Dynamic Head (back pressure)**
10 m water height is 1 Bar (0,1 MPa) back pressure.

As an example, consider an NDP-40 Series Pump with **rubber diaphragms** performance curve. Pump pumping at 250 L/min (66 GPM) (|) at 10 m (33 Feet) (—) back pressure.

Point "●" on the performance curve is where the desired **Flow Rate (l/m or GPM)** and **Total Dynamic Head** points intersect. This point determines compressed air requirements for the particular pump.

At performance point "●"; the pump will require approximately 3 Bar (0,3MPa or 45 PSI) air inlet pressure.

To arrive at this figure, follow the solid curve (—) to the left to read the air pressure rating in MPa.

By looking at the dashed line (- - -), it is determined the pump will require approximately 1500 L/min of air volume.

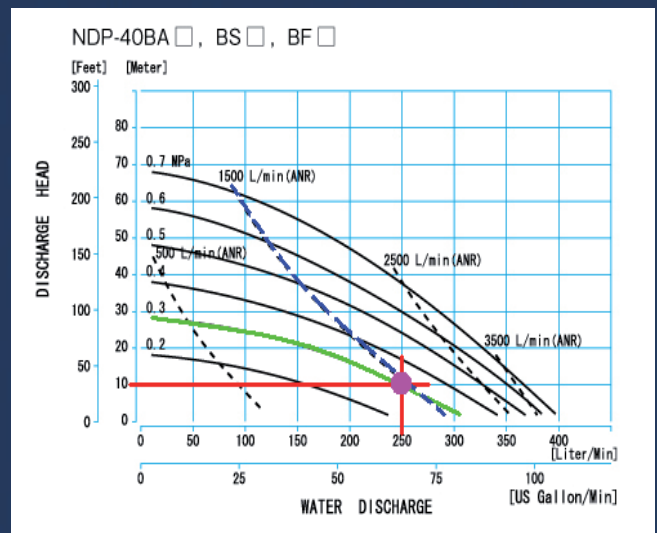

0,1 MPa	= 1 Bar
1 Bar	= 14,5 PSI
1 l	= 0,26 Gallon (gal.)
1 m	= 3,28 Feet (ft.)
1 m ³ /h	= 0,58 SCFM
1000 L/min	= 34 SCFM
	(Standard Cubic Feet Per Minute)

Yamada

www.yamada-europe.com

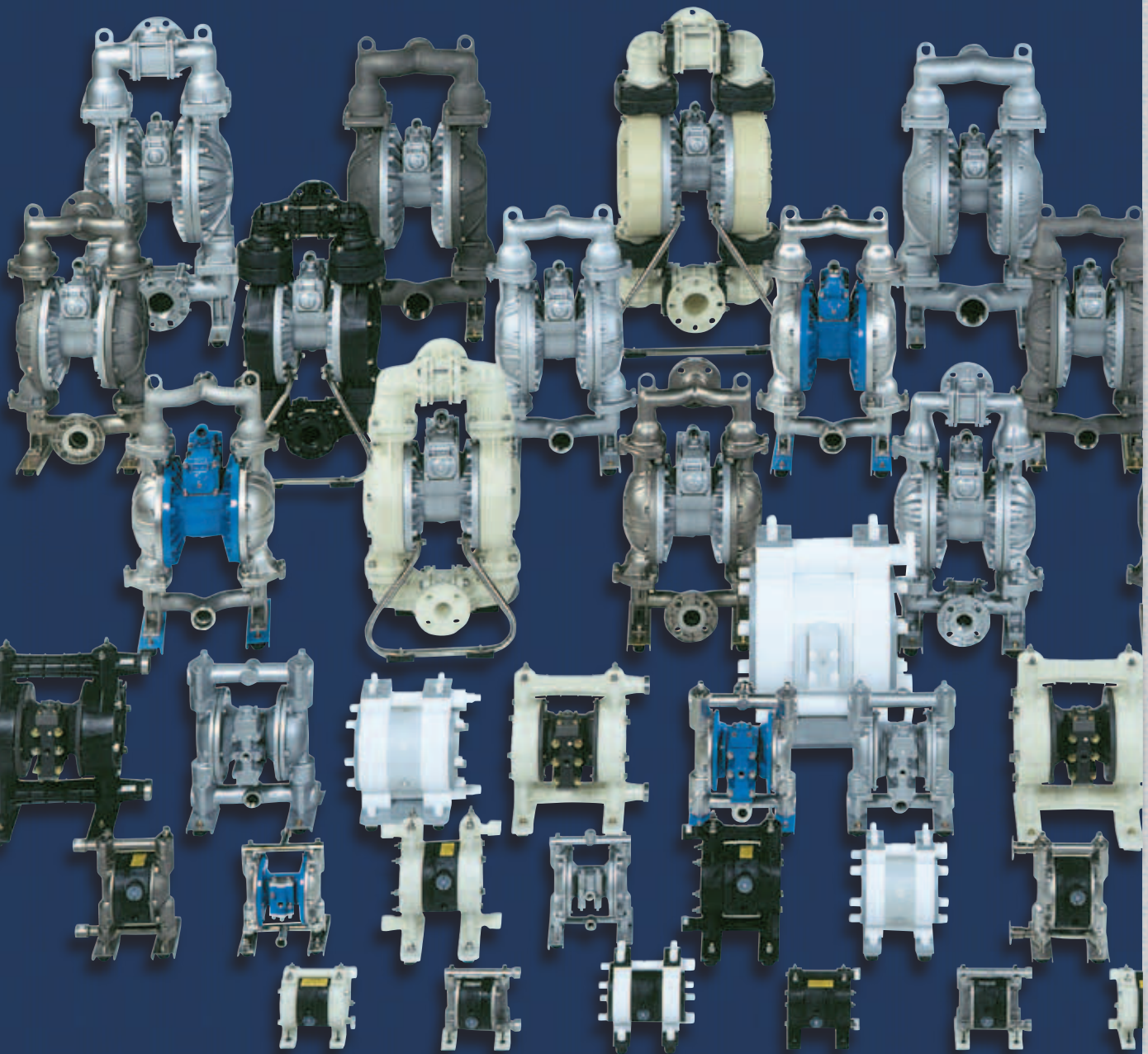

Due to Dutch, European and other international trade laws, Yamada-products may require licensing prior to export or re-export. We request that when dealing with Yamada-products that you take the utmost care in ensuring that all required legal procedures are carried out correctly.

Your Local Distributor/Sales & Service Centre:

Yamada Europe BV
Aquamarijnstraat 50
7554 NS Hengelo (OV)
The Netherlands

Telefon +31 (0)74-242 2032
E-mail: sales@yamada-europe.com
Internet: www.yamada-europe.com